



COMMERCIAL VEHICLE AUCTIONS LTD
THE UK'S MOST ESTABLISHED COMMERCIAL VEHICLE AUCTIONEERS

Carr Hill Industrial Estate
Doncaster
DN4 8DE

01302 732600 | cva.noreply@cva-auctions.co.uk

VEHICLE INSPECTION REPORT

YG73UMB

Maxus T90 130KW ELITE 88.5KWH

| Inspection | | Vehicle | |
|-----------------|----|---------|----------|
| Serious Damage? | No | VAT | Plus VAT |
| | | V5 | Present |

| Details | | | | | |
|-----------|---------------------------|-------------|-------------------|------------|-----------|
| Reg. date | 29/12/2023 | Colour | GREY | CAP Below | £9,225.00 |
| Year | 2023 | VIN | LSFAM1206NA176878 | Gearbox | AUTOMATIC |
| Mileage | 15,408 Miles Warranted | Body Style | Pickup Double Cab | Gears | 6 |
| Fuel Type | Electric | CAP Clean | £11,550.00 | Axle Combi | 4x4 |
| GVW | 3300kg | CAP Average | £10,750.00 | | |

WARNING LIGHTS ON DASH E/MIRRORS

| Tyres | |
|-------|-----------|
| NSF | |
| NSR | Punctured |
| OSF | |
| OSR | |
| Spare | |

Features

- Bluetooth connection
- Digital radio
- Metallic Paint
- Leather seat trim
- Park assist camera
- Air conditioning
- Drivers airbag
- Rear parking sensor
- Front electric windows
- Passenger airbag
- Auxiliary input socket
- Rear electric windows
- Central locking

Photos



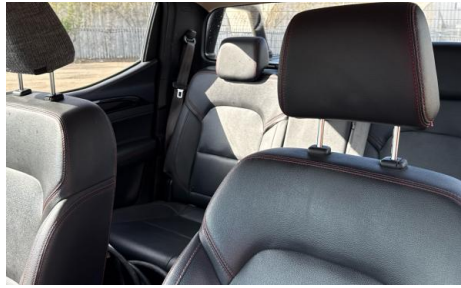

Condition Check

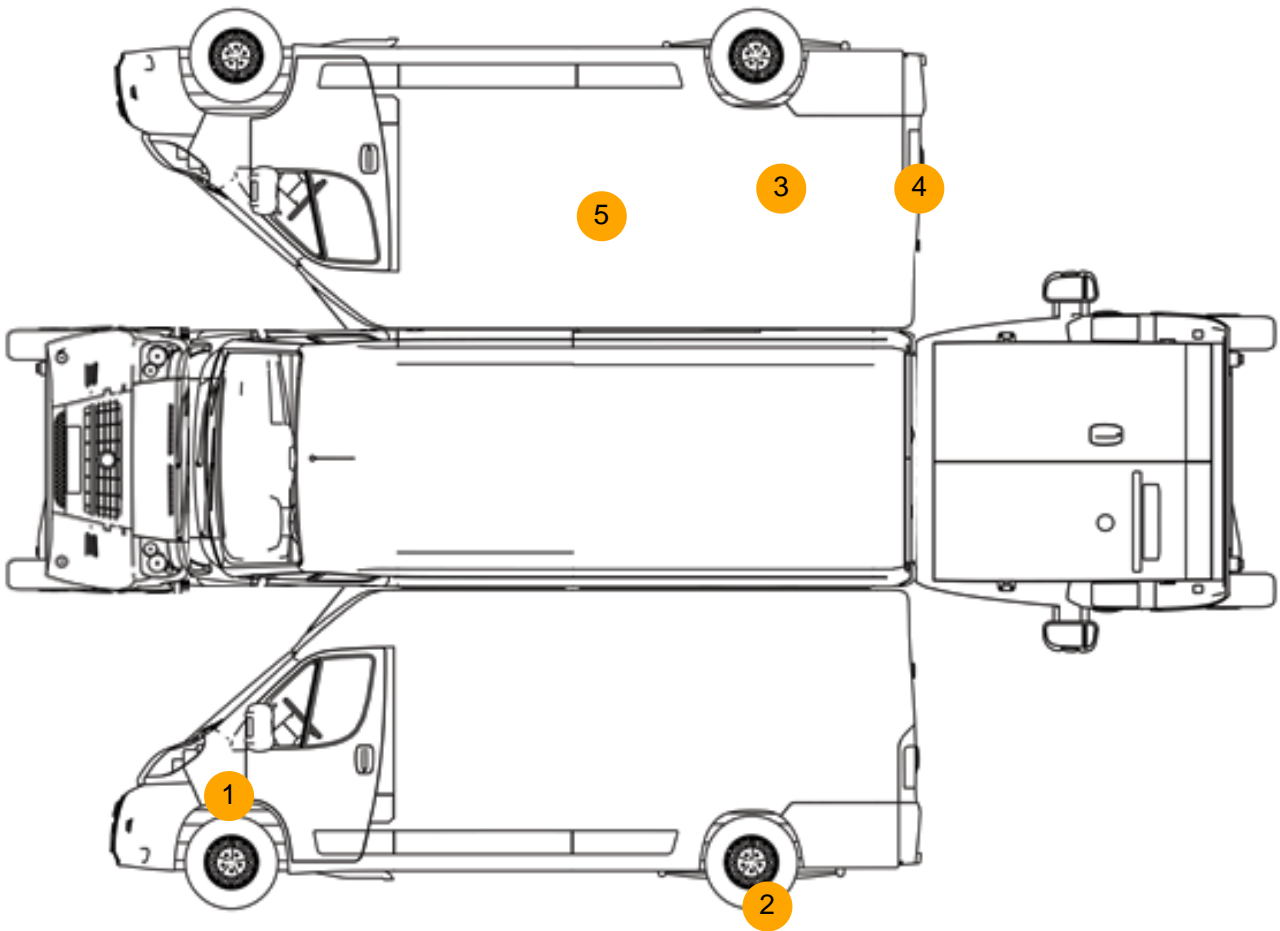

Damage Photos

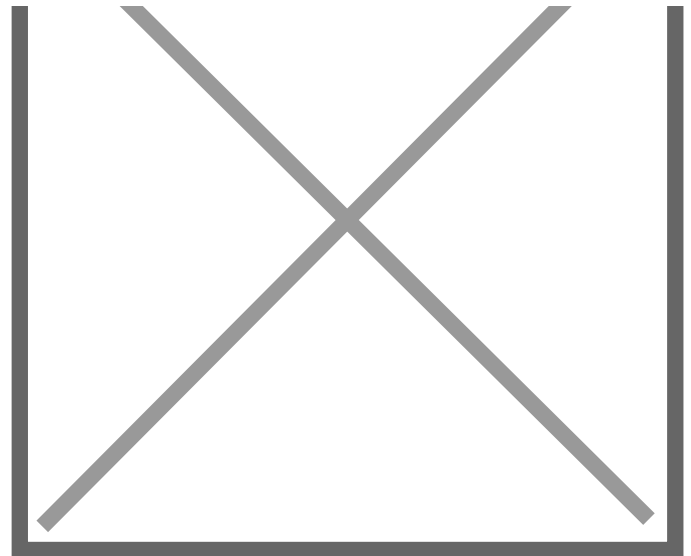
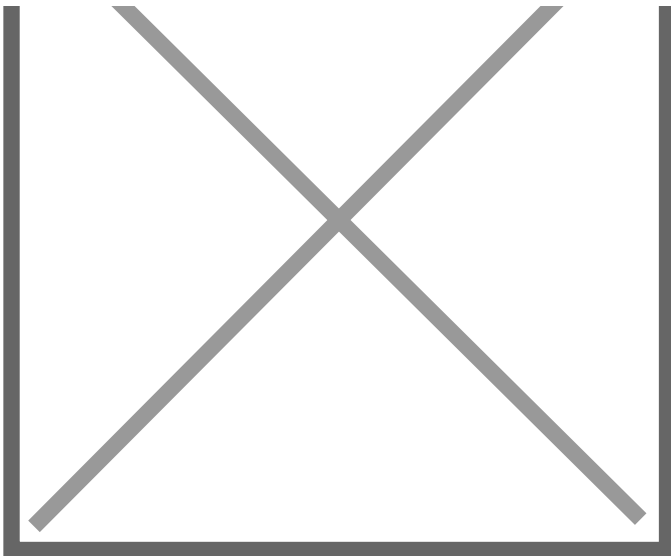

1: Wing nsf
Scratched
Over 25mm Thru Paint

2: Other
N/A
N/A

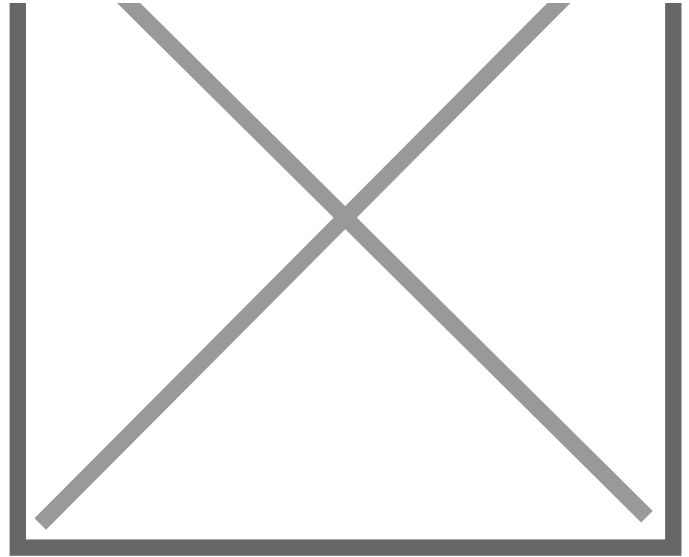
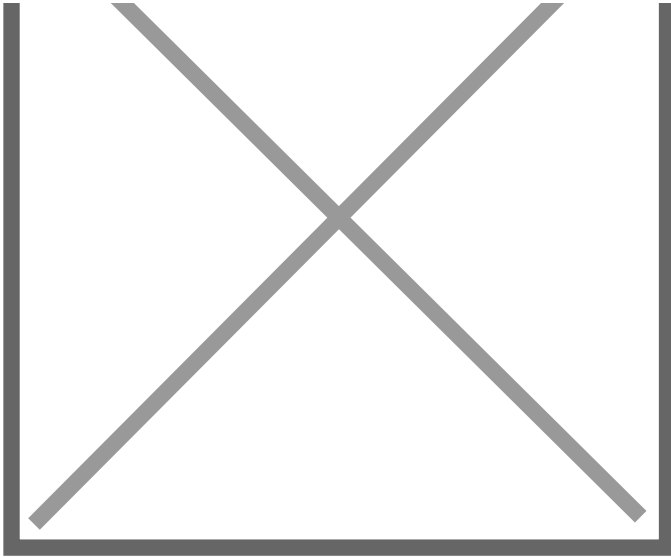

3: Qtr Panel osr
 Scratched
 Over 25mm Thru Paint

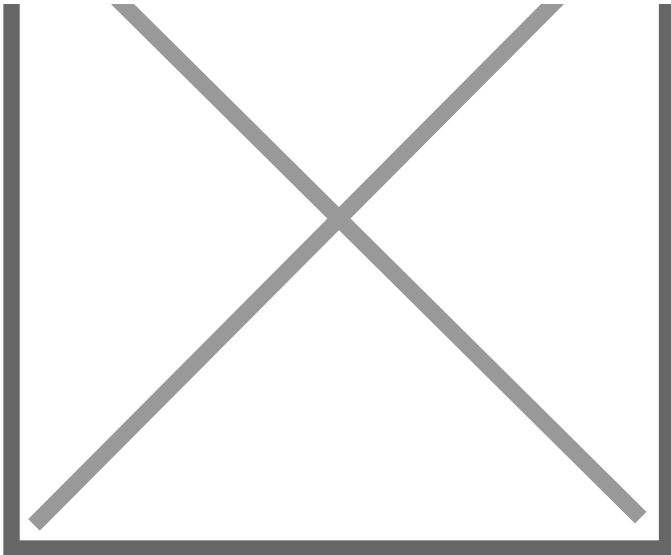

4: Qtr Panel osr
 Scratched
 UpTo 25mm Thru Paint

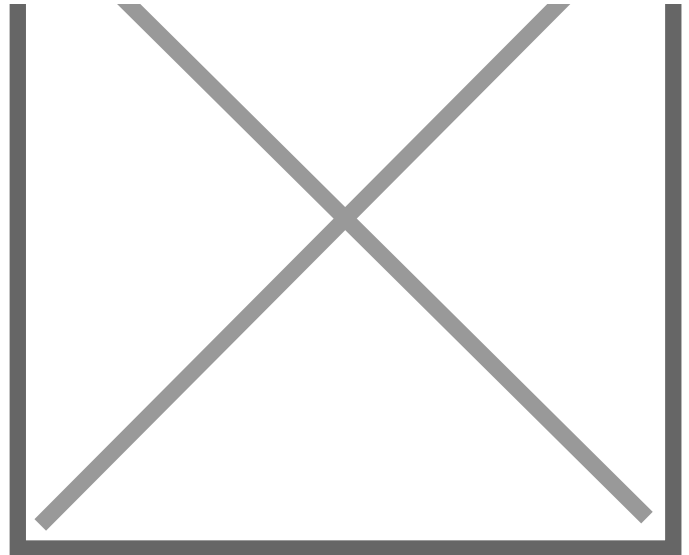

5: Door osr
 Scratched
 UpTo 25mm Thru Paint

6: Dash Warning Lights
 Displayed
 No Action

Interior

Carpet Condition OK
Seat Condition OK

Upholstery Condition OK
Odour No

Service indicator light illuminated Fault