



**COMMERCIAL VEHICLE AUCTIONS LTD**  
THE UK'S MOST ESTABLISHED COMMERCIAL VEHICLE AUCTIONEERS

Carr Hill Industrial Estate  
Doncaster  
DN4 8DE

01302 732600 | cva.noreply@cva-auctions.co.uk

# VEHICLE INSPECTION REPORT

**WJ65YTV**

## Isuzu D-Max 2.5TD

Inspection		Vehicle	
Serious Damage?	No	VAT	Plus VAT
		V5	Buyer To Apply

Details					
Reg. date	03/11/2015	Colour	WHITE	CAP Average	£3,575.00
Year	2015	VIN	MPATFS86JFT005093	CAP Below	£2,525.00
Mileage	125,864 Miles Warranted	Body Style	Pickup Double Cab	Gearbox	MANUAL
Fuel Type	Diesel	MOT Due	Expired	Gears	6
GVW	3050kg	CAP Clean	£4,450.00	Axle Combi	4x4

\*COLLECTED AS NON-RUNNER, GEARBOX FAULT, BRAKES GRINDING, WARNING LIGHTS ON DASH\*  
TWIN SIDE LOAD DOOR, TOW BAR, E/ MIRRORS, HEATED WINDSCREEN, V5 NEW KEEPER DOCUMENT  
REFERENCE NUMBER AVAILABLE FOR TAXATION PURPOSES

Tyres
NSF
NSR
OSF
OSR
Spare

## Features

- Bluetooth connection
- Air conditioning
- Front electric windows
- Drivers airbag
- Passenger airbag
- Central locking
- Cloth seat trim

## Photos



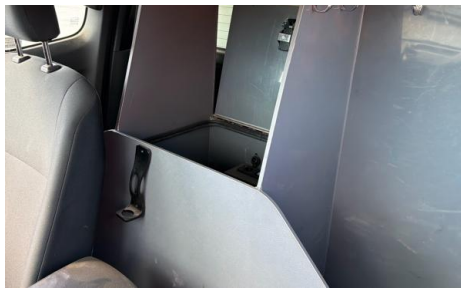

## Condition Check

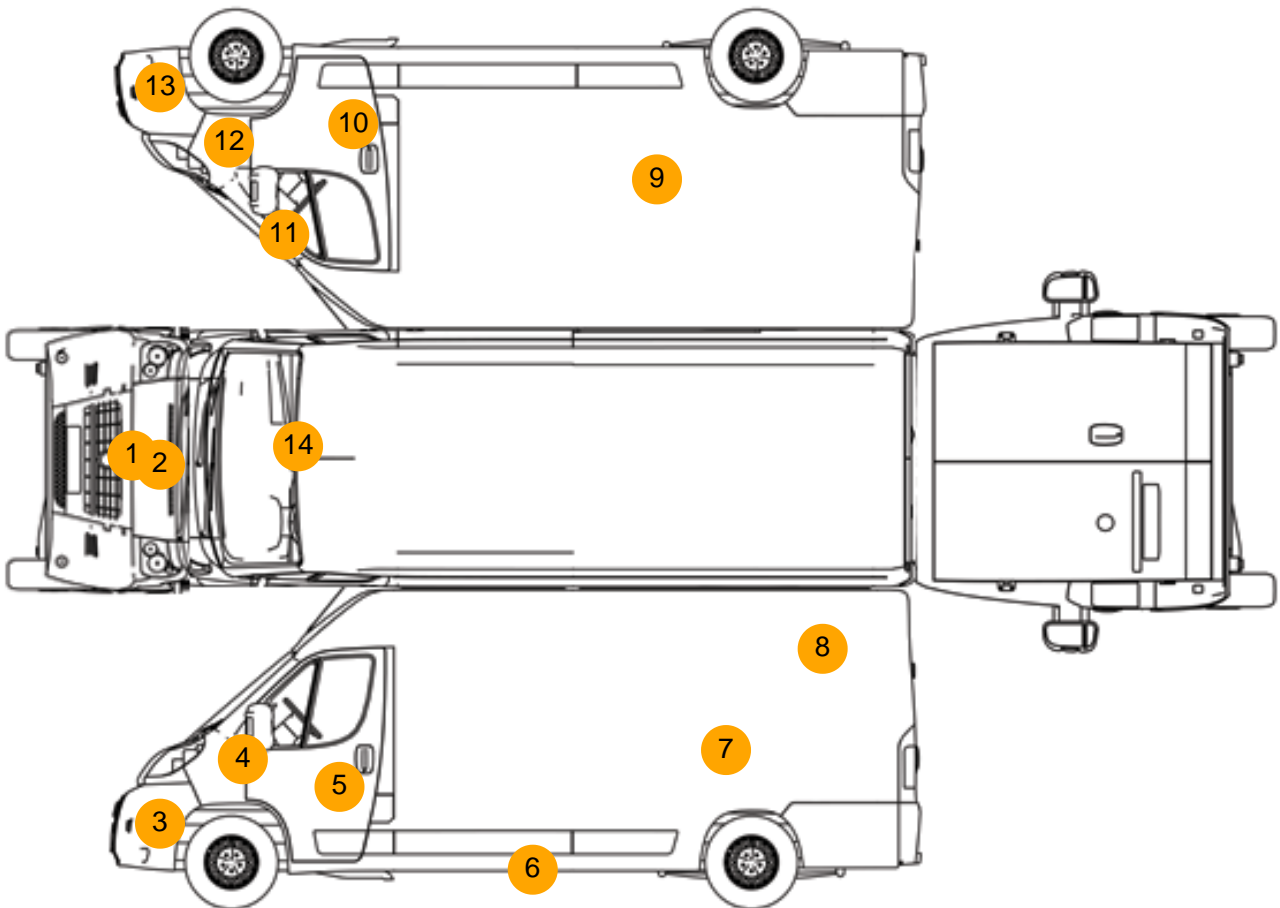

## Damage Photos

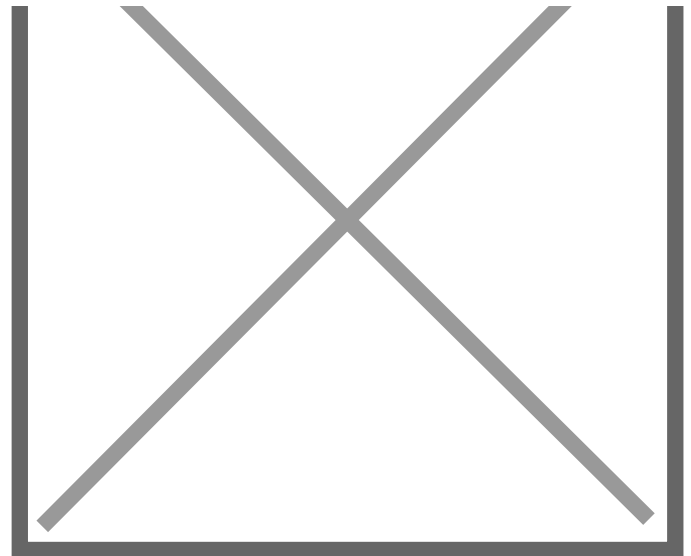
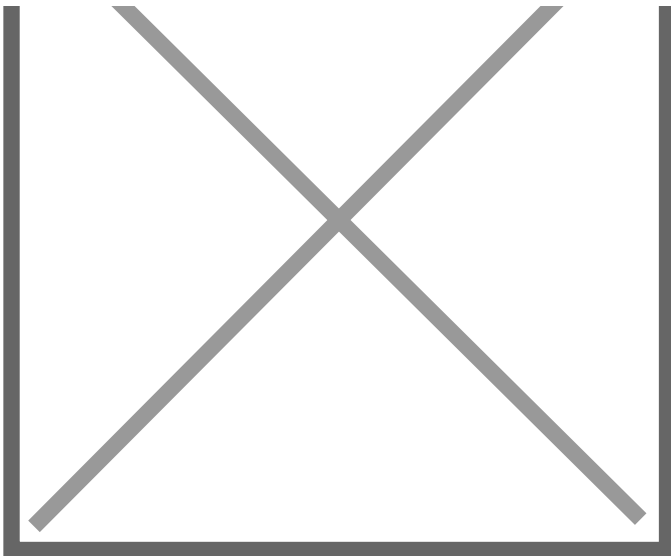

1: Bonnet  
Chipped  
Multiple Chips

2: Bonnet  
Rusted  
Over 5mm

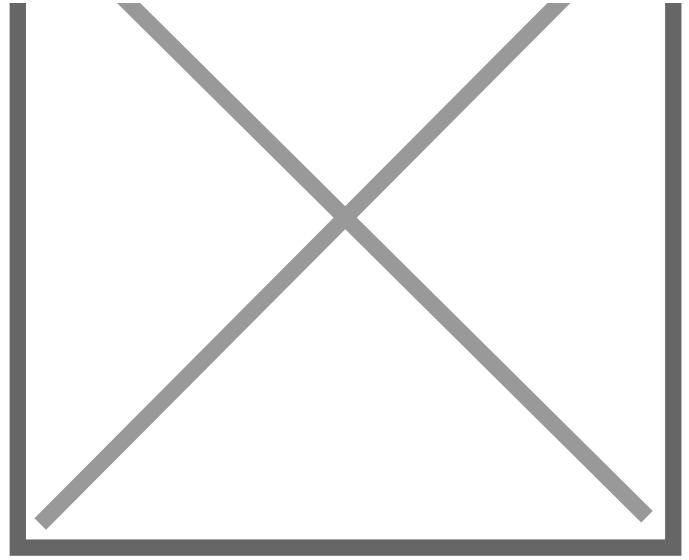
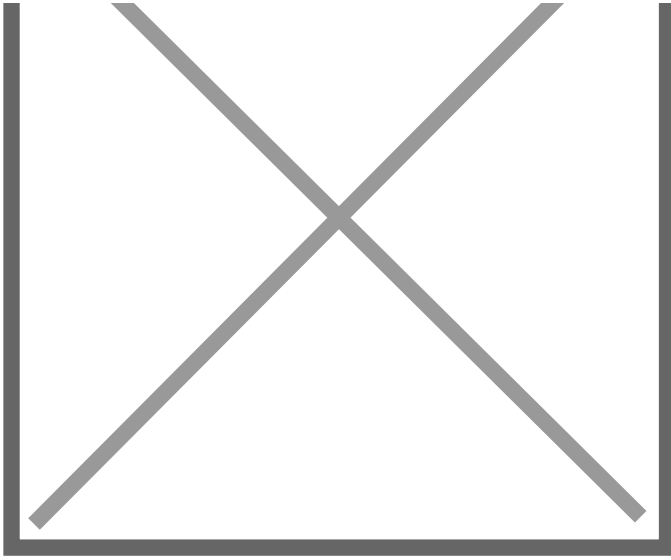

3: Bumper Front  
Scratched  
Over 100mm Thru Paint

4: Wing nsf  
Scratched  
Rusted

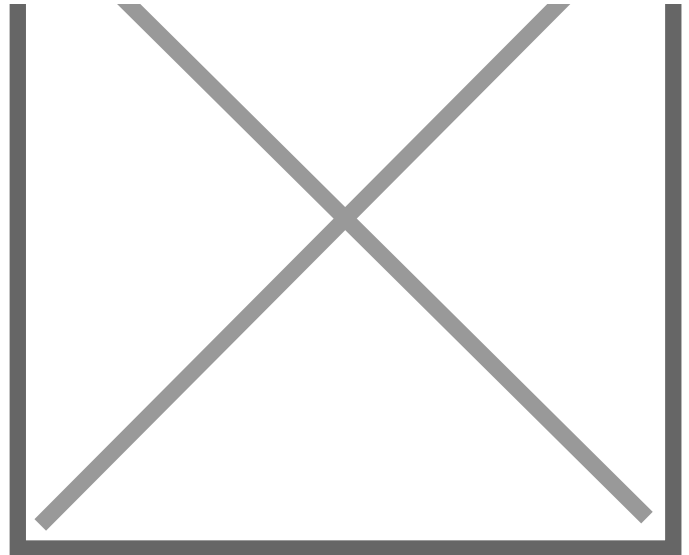
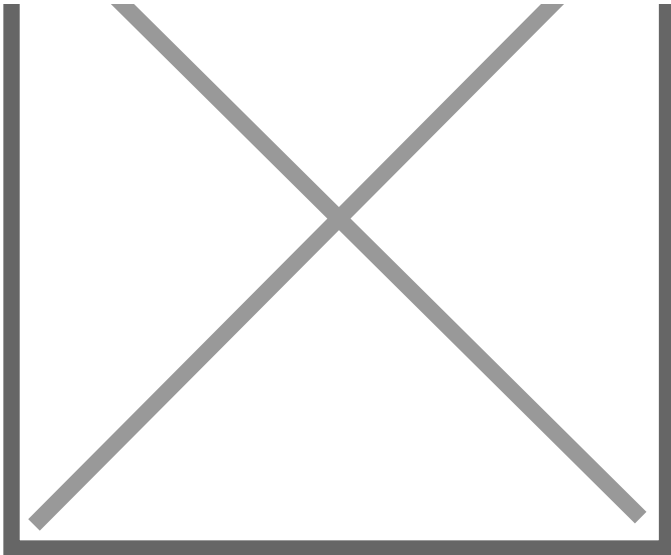

5: Door nsf  
Scratched  
Rusted

6: Sill ns  
Rusted  
Over 5mm

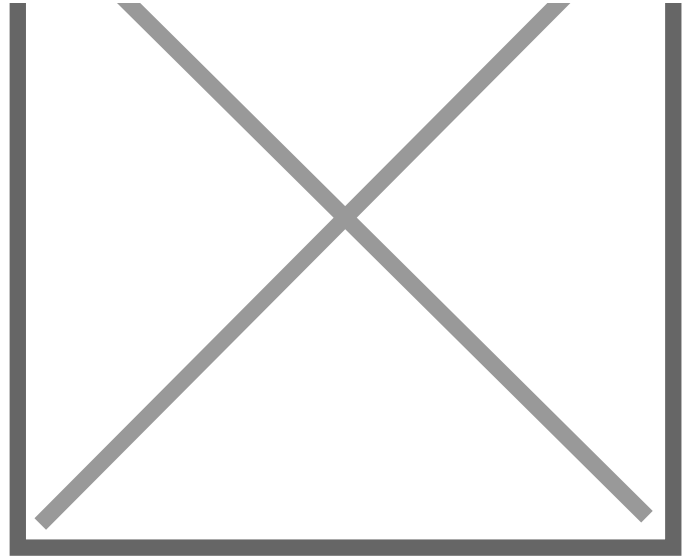
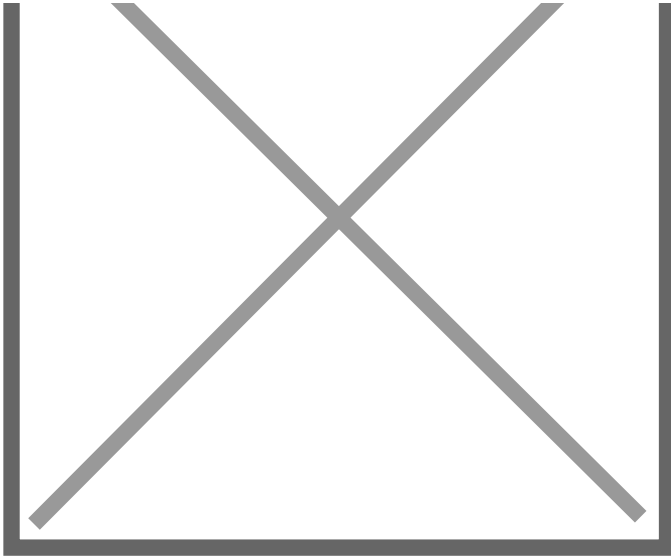

7: Qtr Panel nsr  
Scratched  
Rusted

8: Roof  
Scratched  
Over 25mm Thru Paint

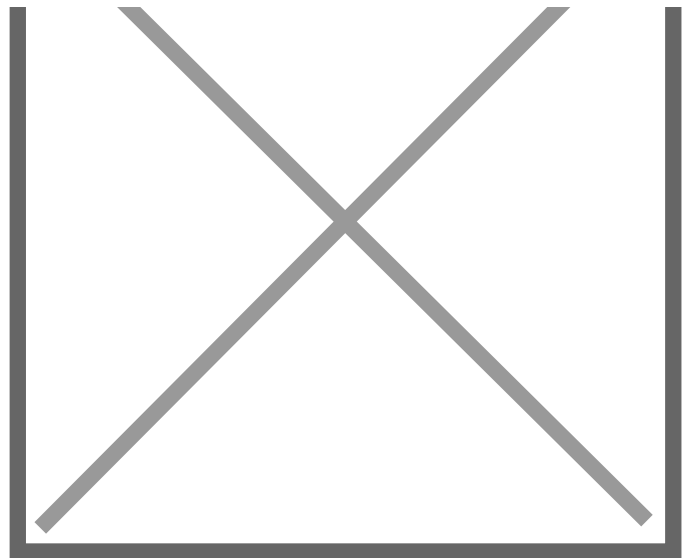
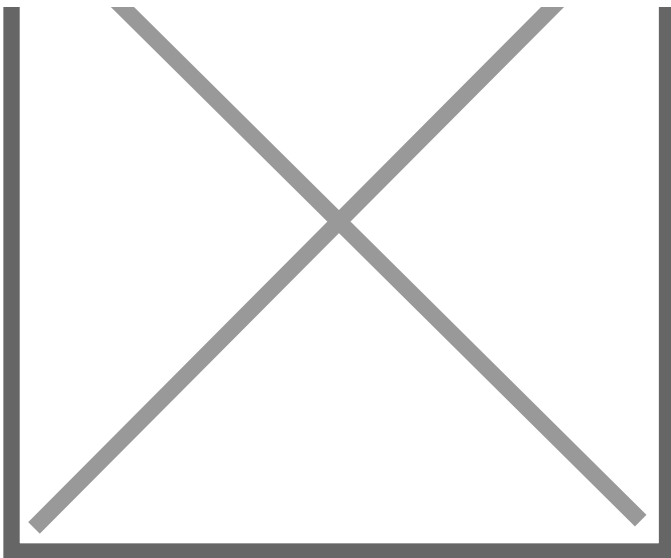

9: Qtr Panel osr  
Dented  
With Paint Damage

10: Door osf  
Scratched  
Rusted

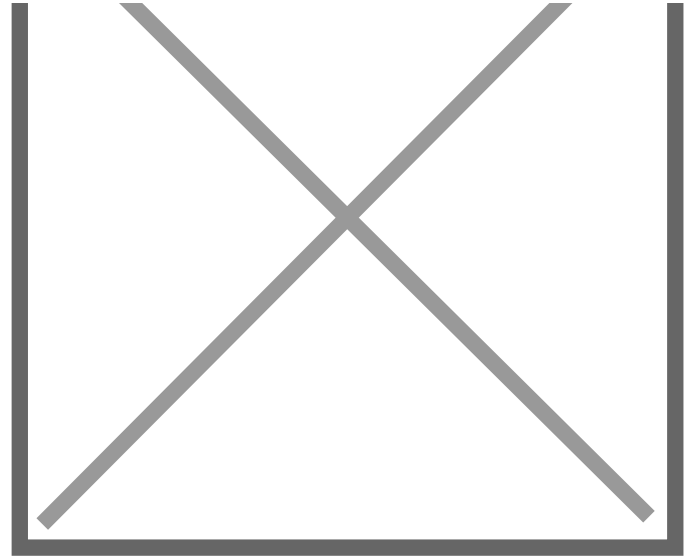
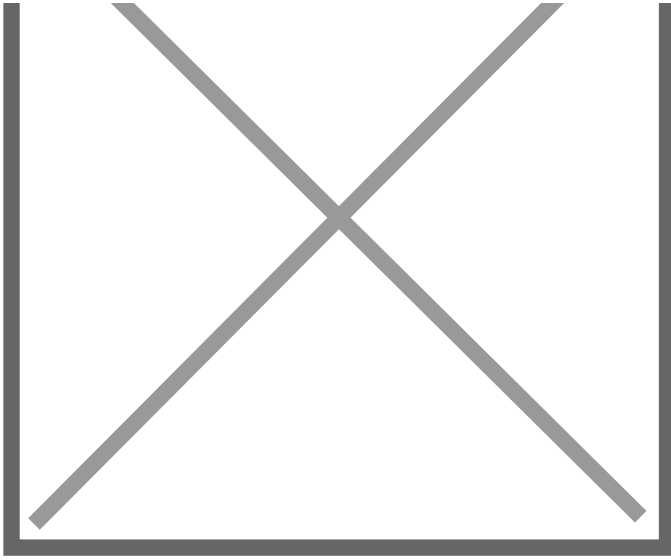

11: A Post os  
Rusted  
Over 5mm

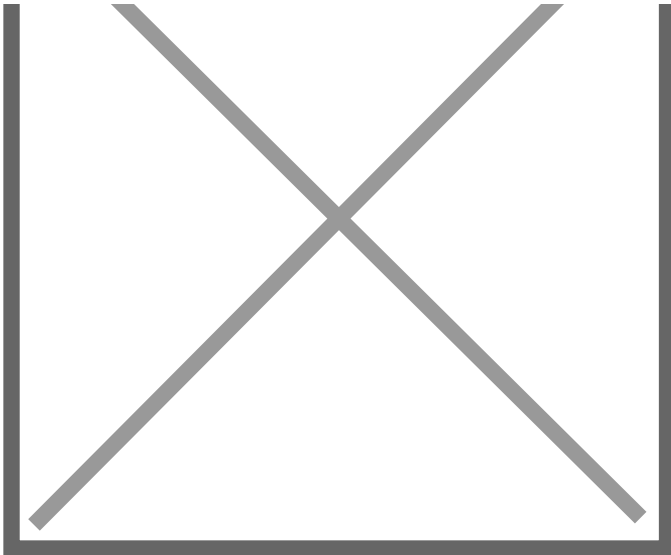

12: Wing of  
Scratched  
Rusted

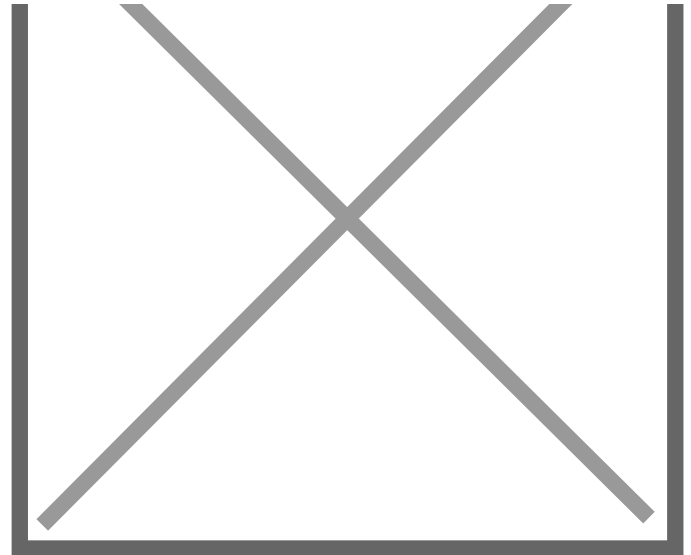

13: Bumper Front  
Scratched  
Over 100mm Thru Paint

14: Screen Front  
Chipped  
Over 10mm

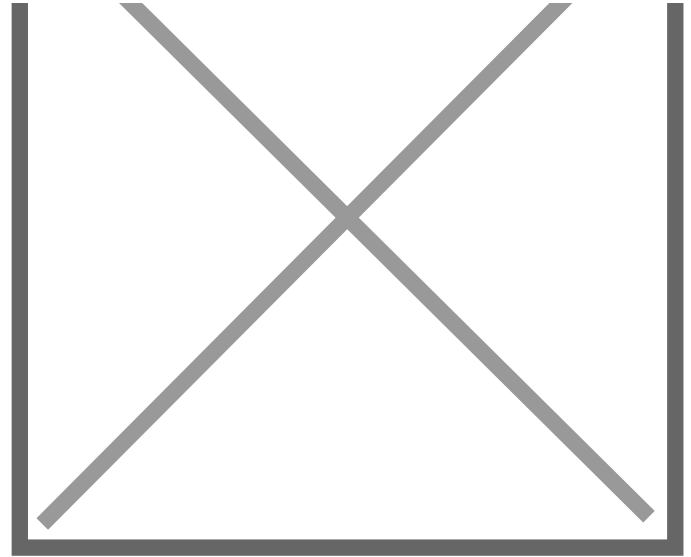
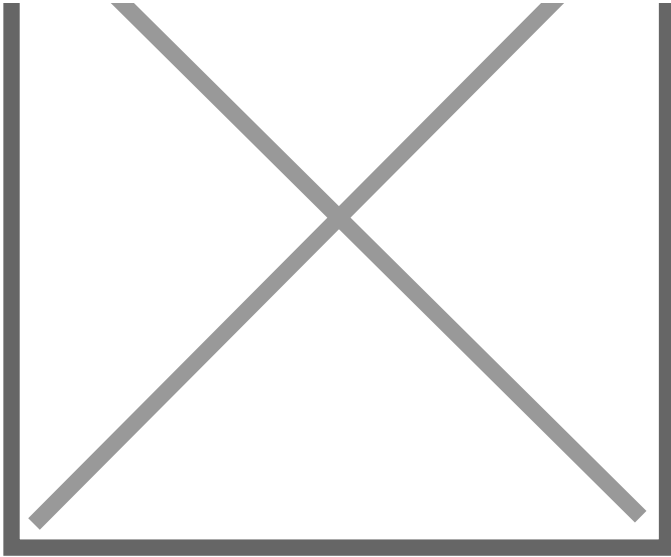

15: Dash Warning Lights  
Displayed  
No Action

16: Centre Console Front  
Broken  
Replace

**Interior**

**Carpet Condition** OK  
**Seat Condition** OK

**Upholstery Condition** OK  
**Odour** -

Engine Runs	OK	No Excessive Smoking	OK
Brakes	OK		
Parking Brake	OK		
EML light illuminated	Fault		
ABS light illuminated	OK		