



COMMERCIAL VEHICLE AUCTIONS LTD
THE UK'S MOST ESTABLISHED COMMERCIAL VEHICLE AUCTIONEERS

Carr Hill Industrial Estate
Doncaster
DN4 8DE

01302 732600 | cva.noreply@cva-auctions.co.uk

VEHICLE INSPECTION REPORT

PJ20Zfv

Mercedes-Benz Sprinter 314 CDI

Inspection		Vehicle	
Serious Damage?	No	VAT	Plus VAT
		V5	Present

Details

Reg. date	07/08/2020	VIN	W1V9076352P254360	CAP Below	£5,425.00
Year	2020	Body Style	Panel Van L3	Gearbox	AUTOMATIC
Mileage	173,701 Miles Warranted	MOT Due	06/08/2026	Gears	6
Fuel Type	Diesel	CAP Clean	£7,725.00		
Colour	WHITE	CAP Average	£6,775.00		

AD BLUE, SIDE LOADING DOOR

Tyres

NSF
NSR
OSF
OSR
Spare

Features

- Rear parking sensor
- Front electric windows

Photos



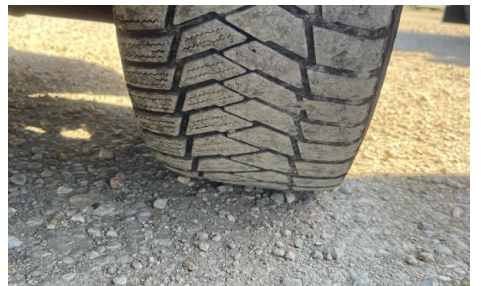

Condition Check

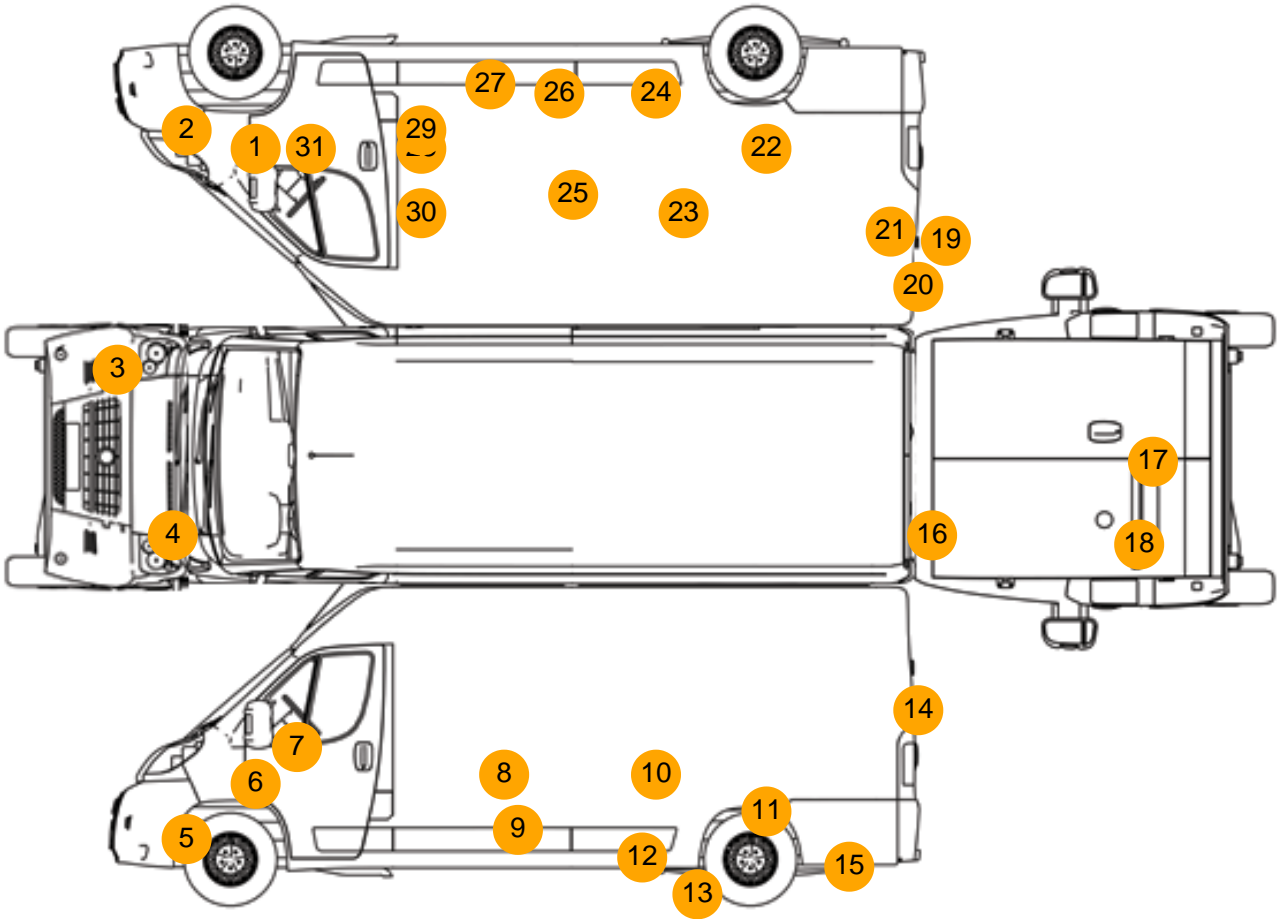

Damage Photos

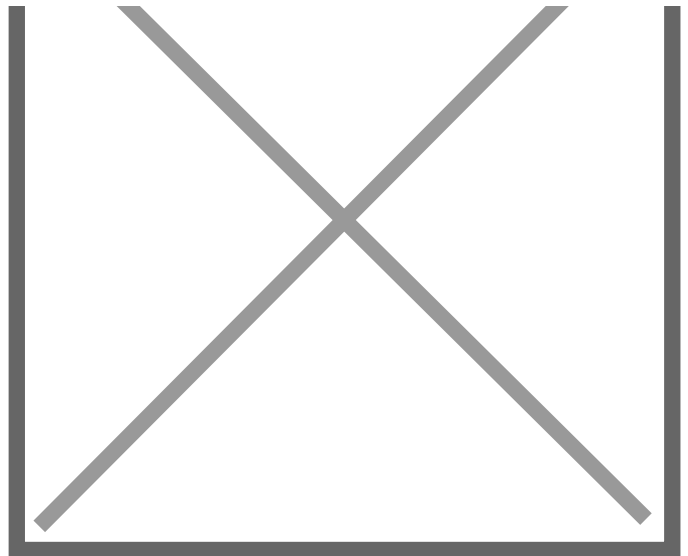
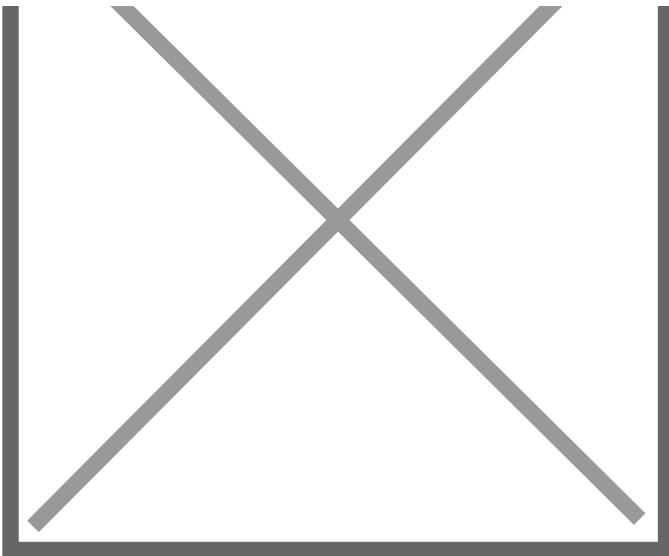

1: Wing of front door
Scratched
Over 25mm Not Thru Paint

2: Bumper Front Moulding
Scuffed (Unpainted)
Over 100mm

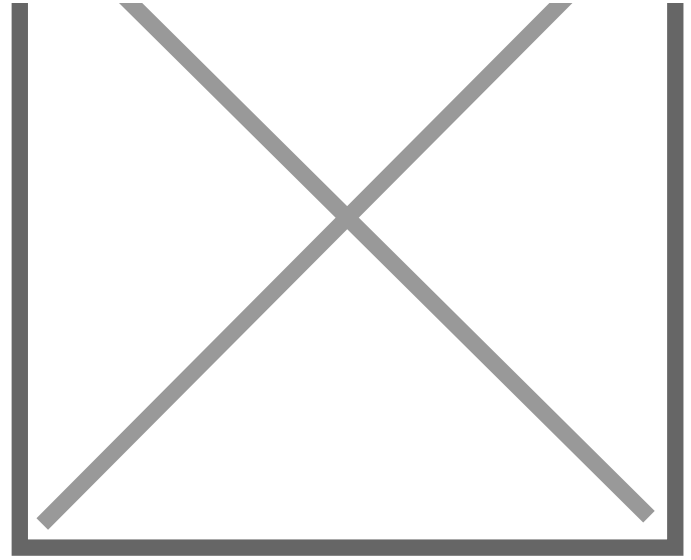
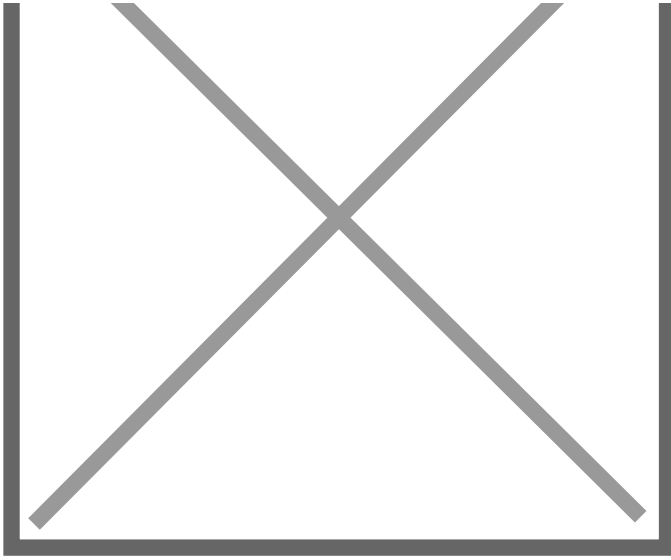

3: Bumper Front
Hole
Up To 25mm

4: Bonnet
Scratched
Over 25mm Not Thru Paint

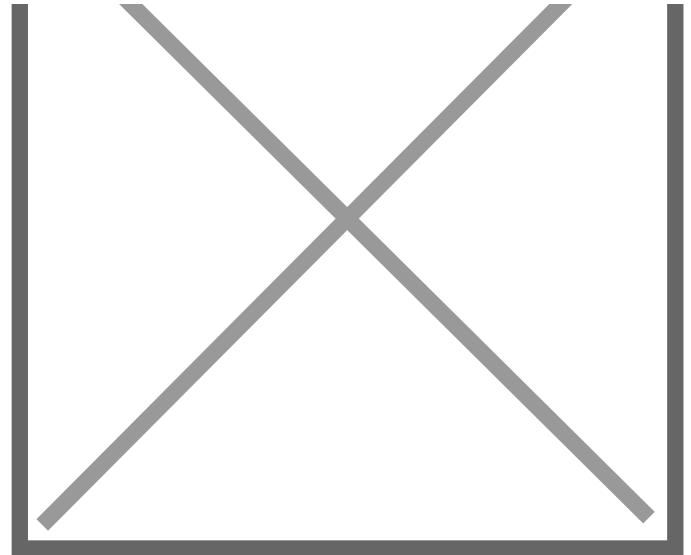
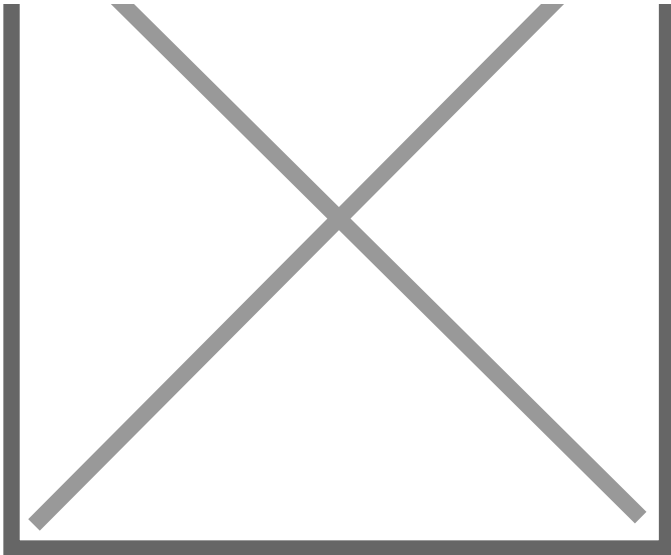

5: Bumper Front Moulding
Scuffed (Unpainted)
Over 100mm

6: Wing nsf
Dented
Over 30% Of Panel

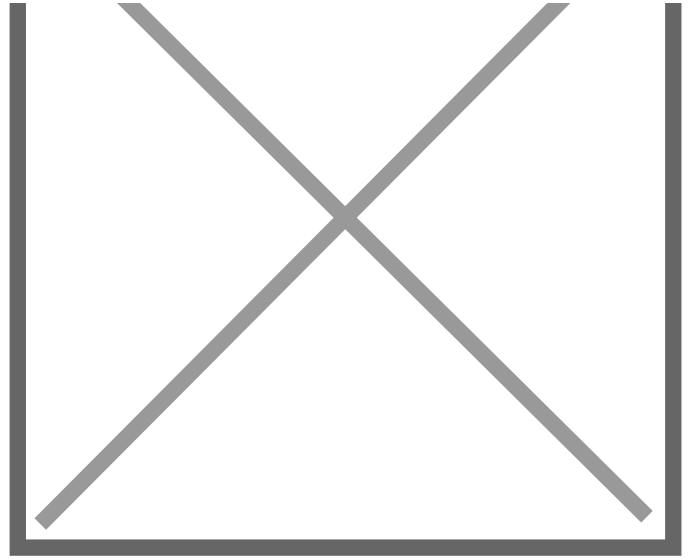
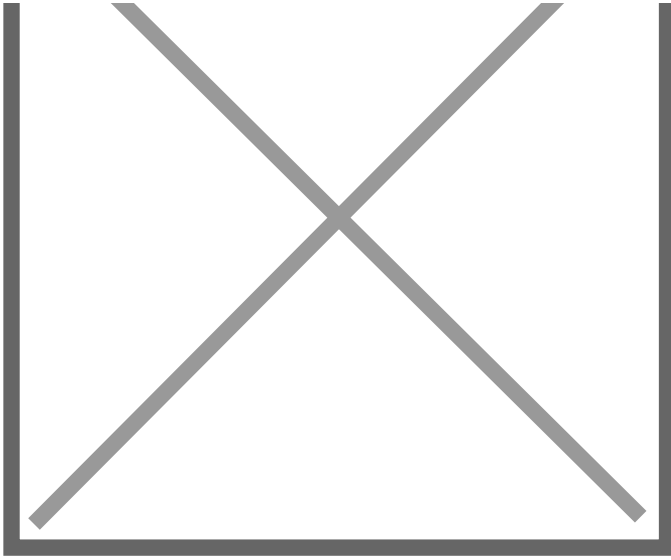

7: Door Mirror Assy nsf
Broken
Replace

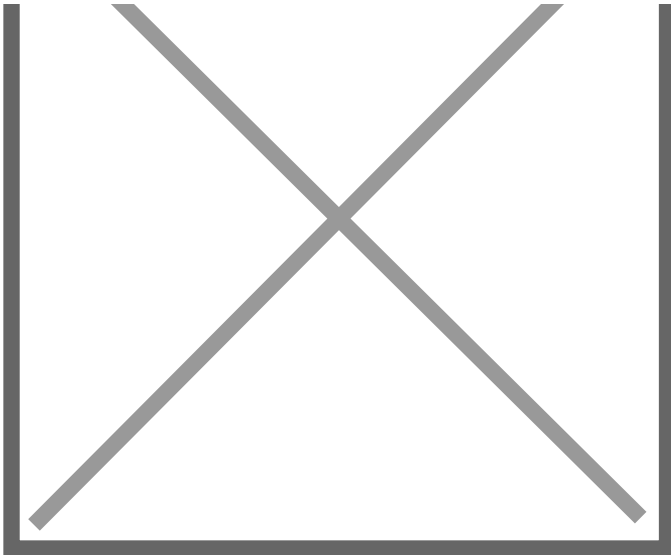

8: Door nsr
Dented
Over 30mm

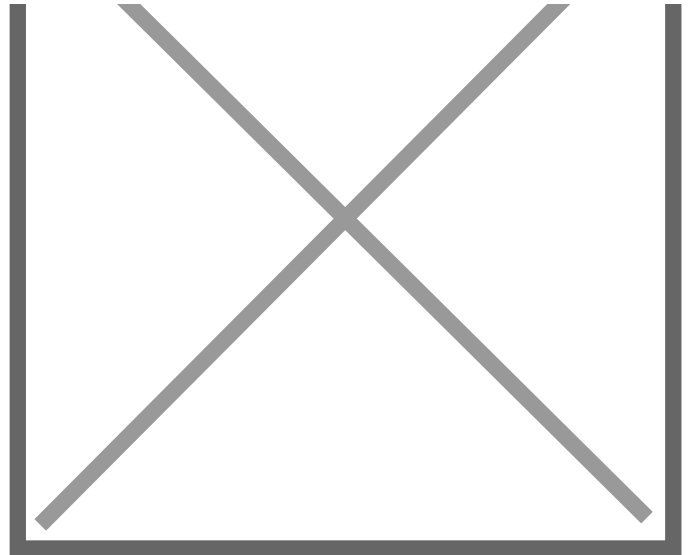

9: Door Moulding nsr
Scuffed (Unpainted)
Over 100mm

10: Qtr Panel nsr
Dented
With Paint Damage

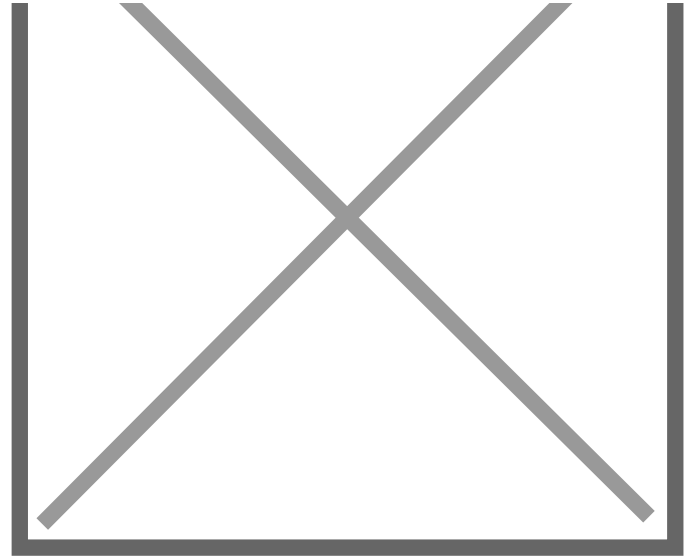
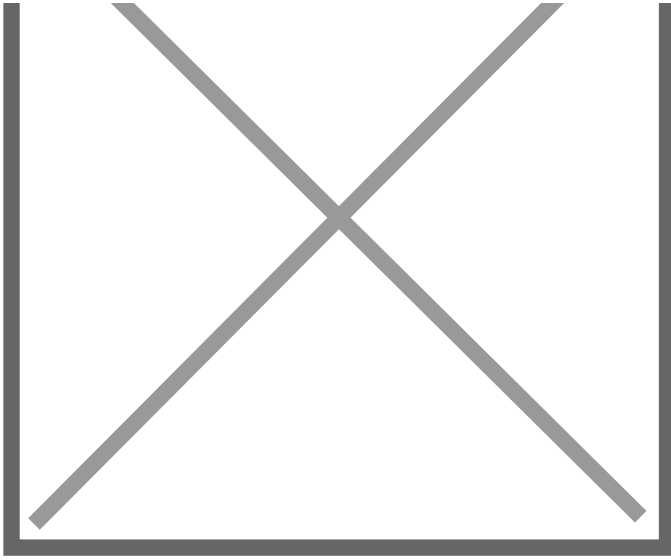

11: Qtr Panel nsr
Scratched
Over 25mm Thru Paint

12: Qtr Panel Trim ns
Scuffed
Over 25mm

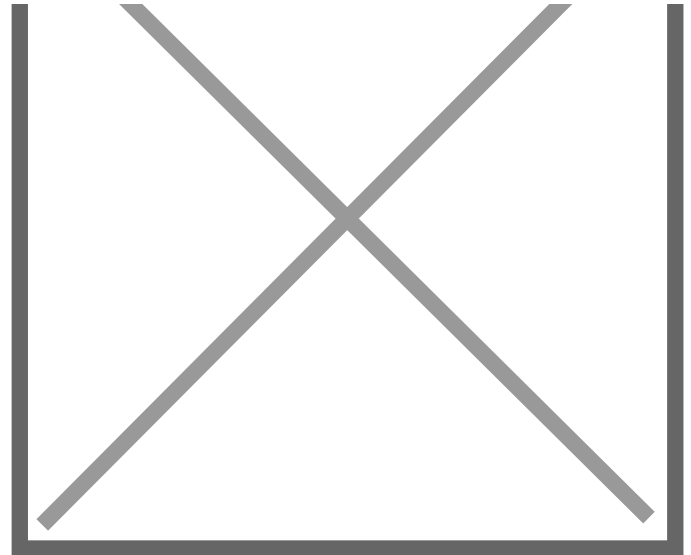
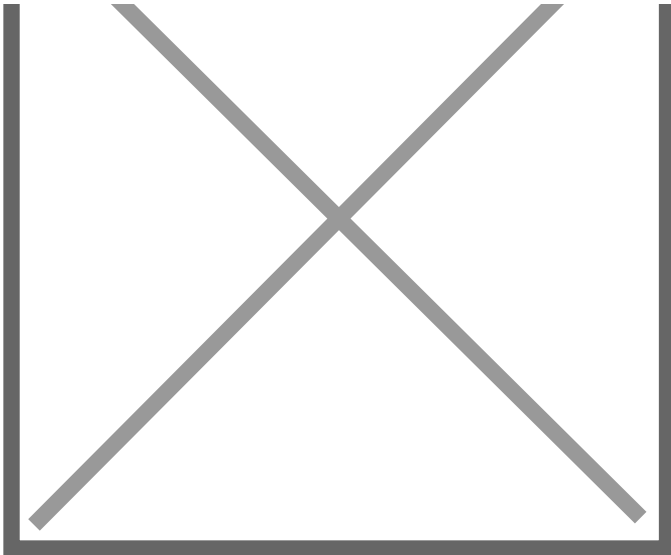

13: Sill ns
Dented
With Paint Damage

14: Qtr Panel nsr
Scratched
Over 25mm Thru Paint

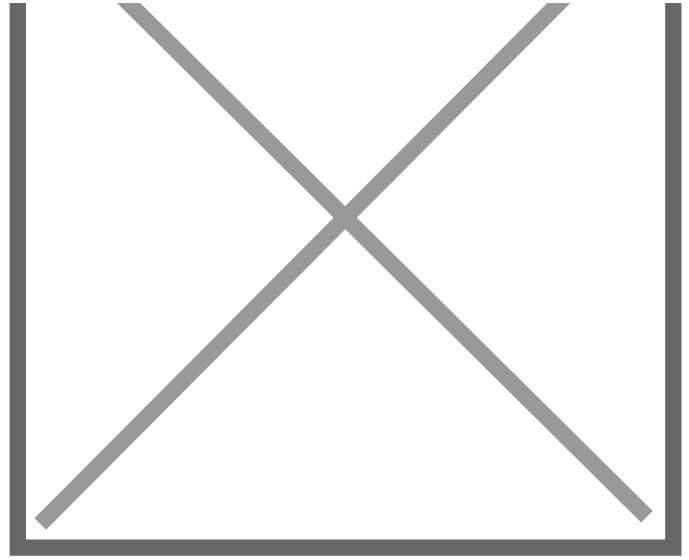
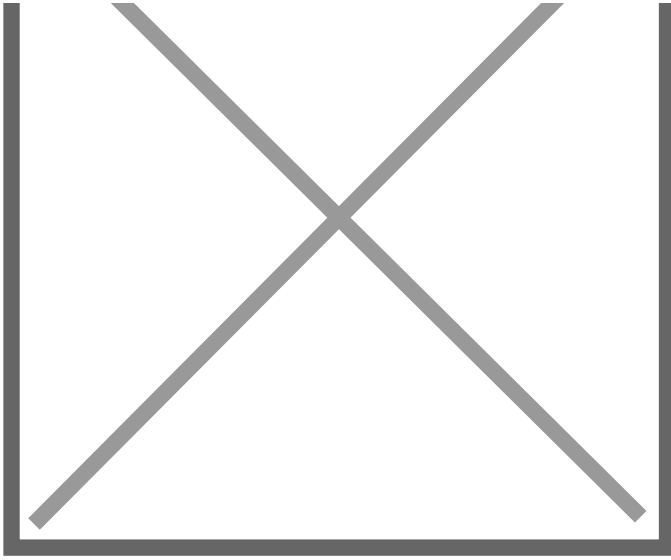

15: Qtr Panel Trim ns
Scuffed
Over 25mm

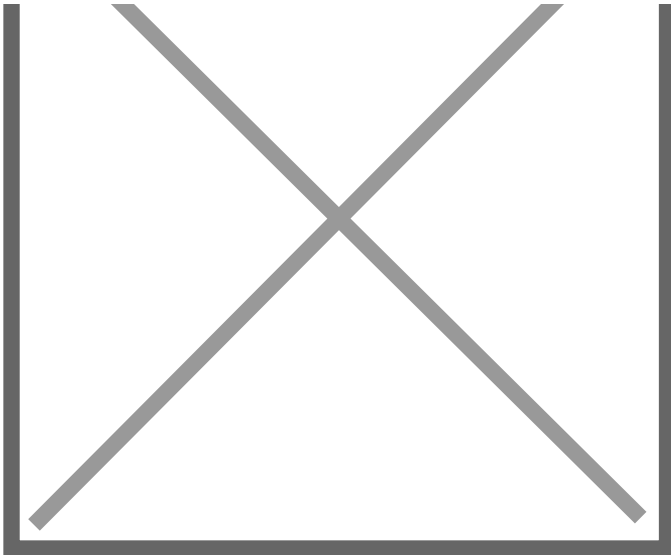

16: Roof
Dented
Over 30mm

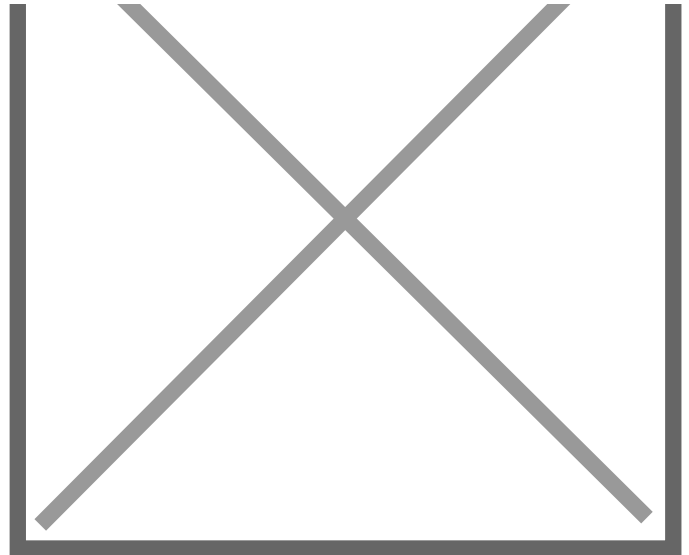

17: Door osr
Dented
With Paint Damage

18: Badgedecal Rear
Missing
Replace

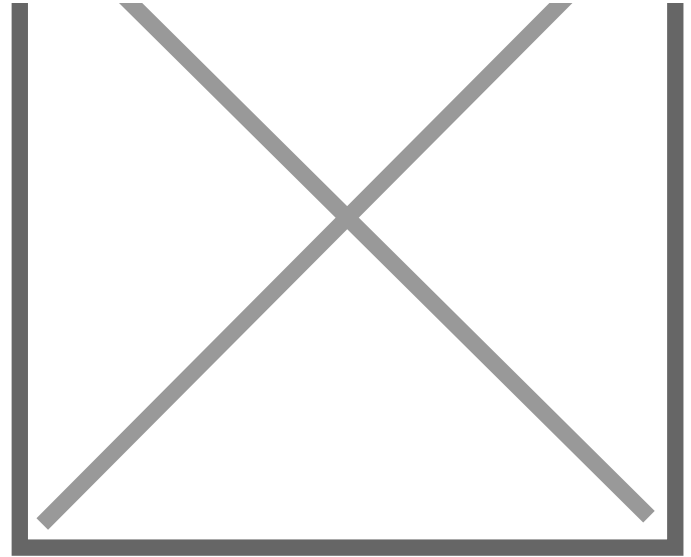
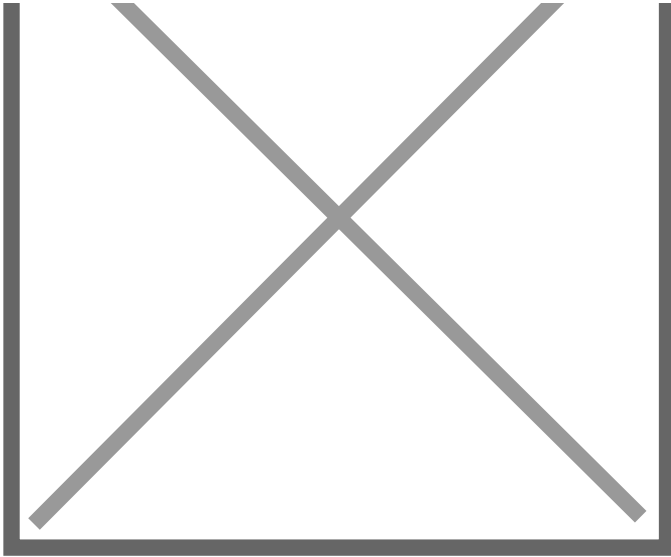

19: Qtr Panel osr
Dented
With Paint Damage

20: Qtr Panel osr
Dented
With Paint Damage

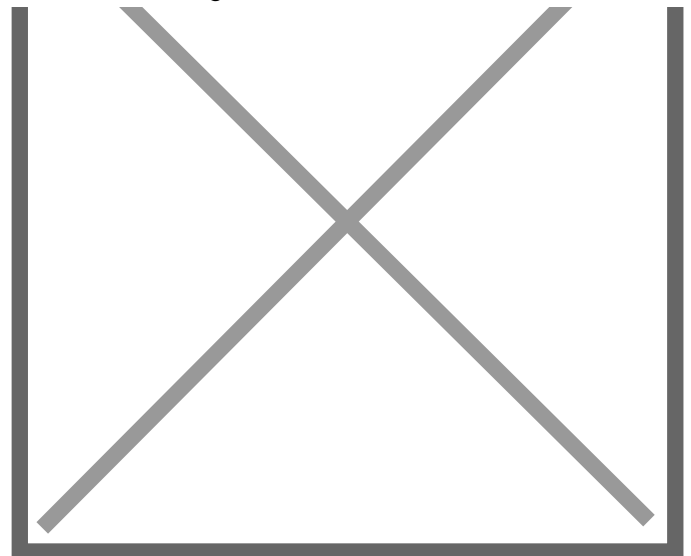
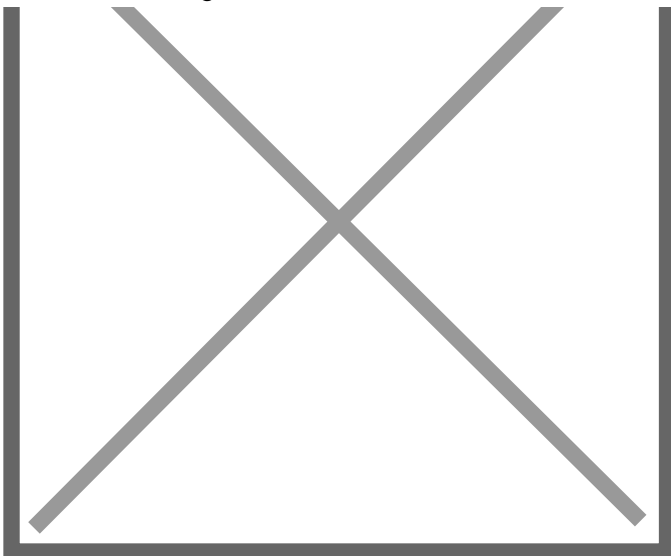

21: Qtr Panel osr
Dented
Between 10mm + 30mm

22: Qtr Panel osr
Scratched
Over 25mm Thru Paint

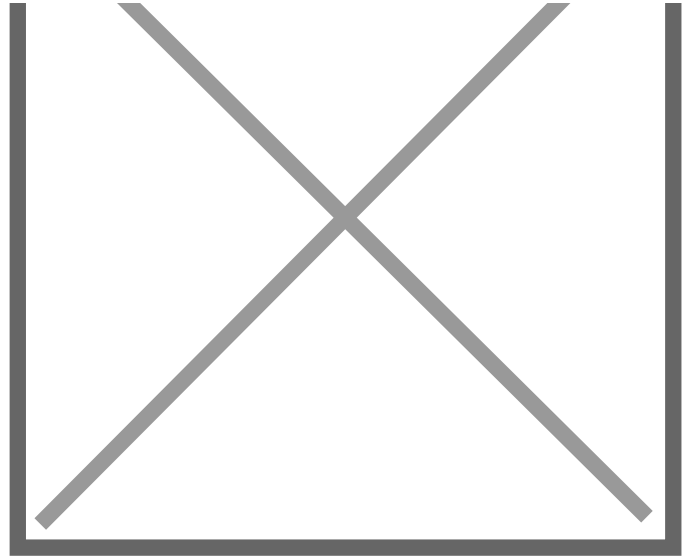
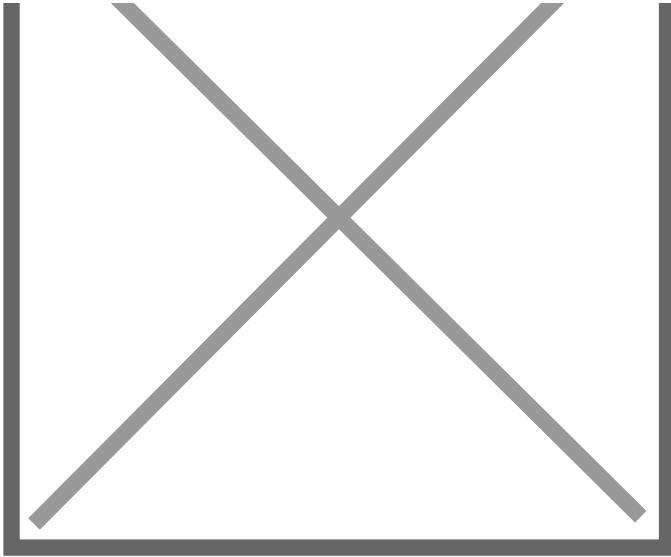

23: Qtr Panel osr
Dented
With Paint Damage

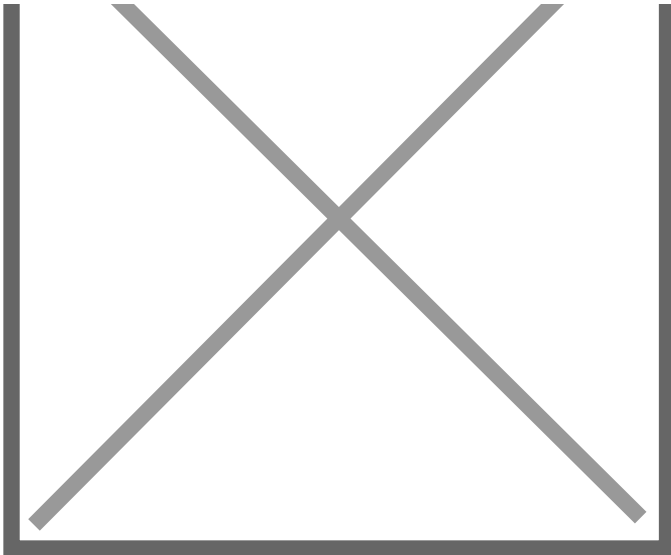

24: Qtr Panel Moulding os
Missing
Replace

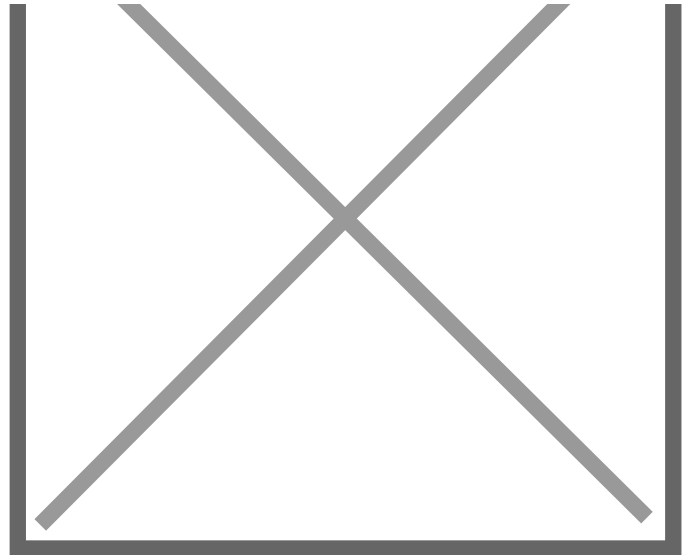

25: Qtr Panel osr
Dented
With Paint Damage

26: Qtr Panel Moulding os
Broken
Replace

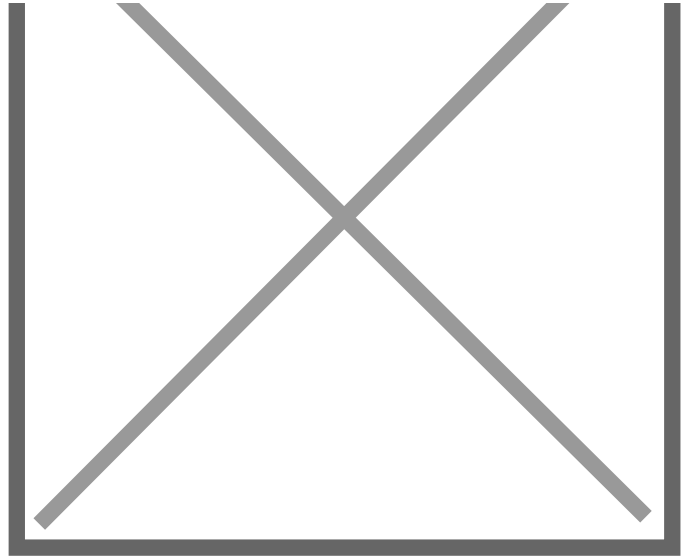
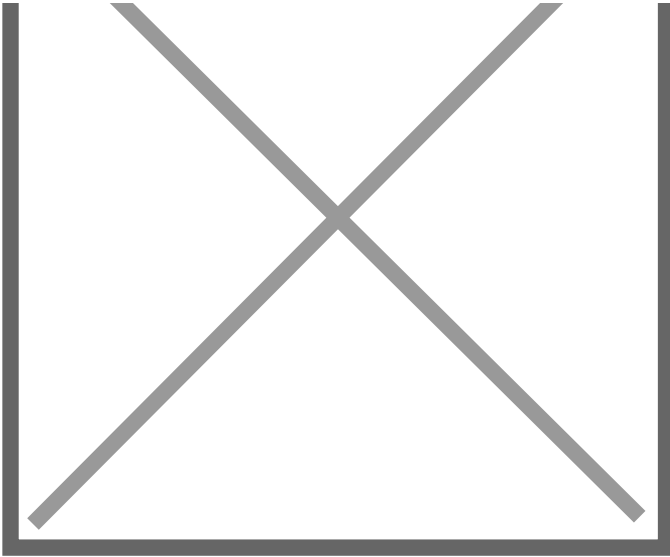

27: Qtr Panel osr
Dented
With Paint Damage

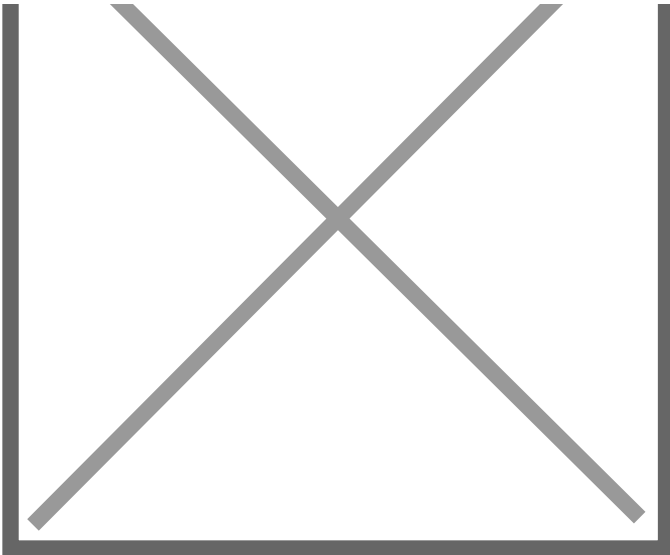

28: B Post os
Dented
With Paint Damage

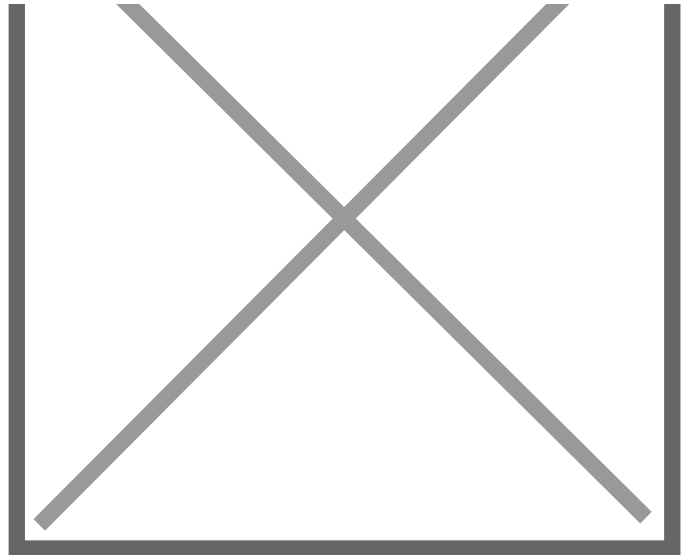

29: B Post os
Missing
Replace

30: B Post os
Scratched
Over 25mm Thru Paint

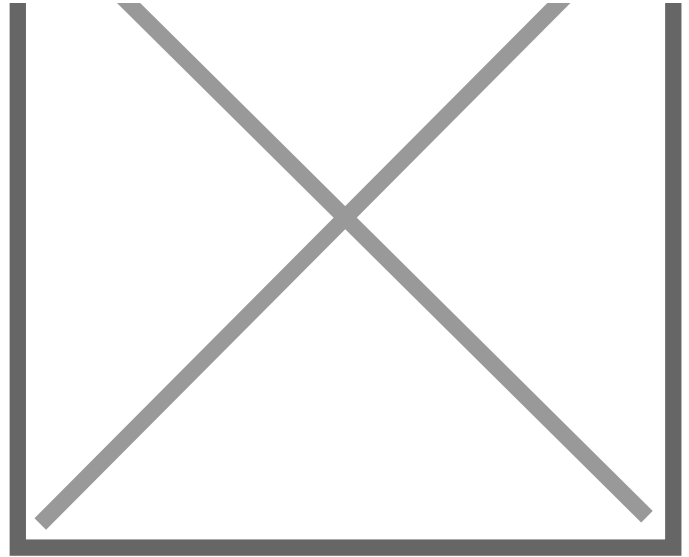
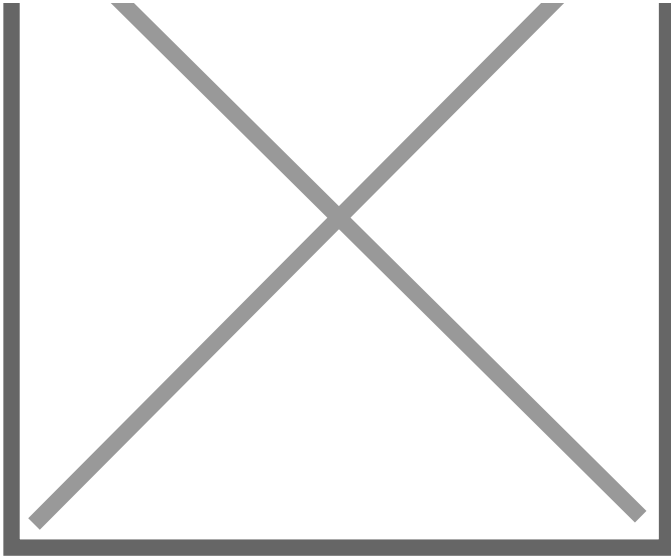

31: Door osf
Dented
Over 30mm

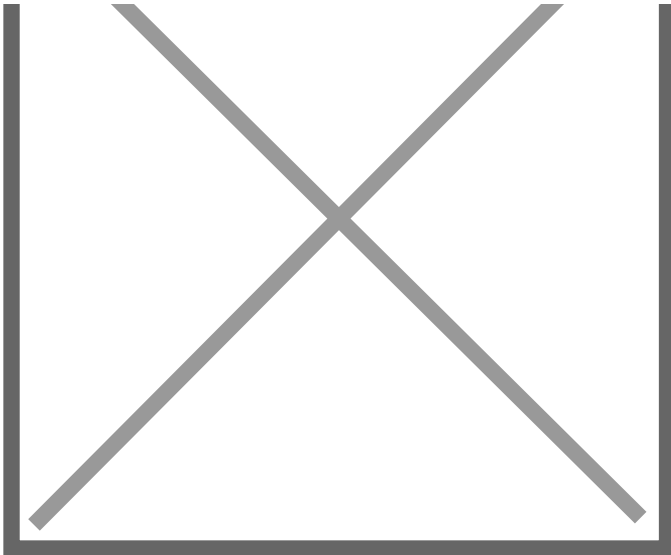

32: Seat Base Cover osf
Holed
Over 3mm

33: Carpets Front
Holed
Over 3mm

Interior

Carpet Condition
Seat Condition

Average
Average

Upholstery Condition
Odour

Average
No

Engine Runs	OK	Gearbox 1st and Reverse Test	OK
Brakes	OK	Clutch Slip Test from Static	OK
Parking Brake	OK	Gearbox Static Gear Selection (engine running)	OK
		No Excessive Smoking	OK

EML light illuminated	OK	Oil warning light illuminated	OK
Airbag light illuminated	OK	DPF light illuminated	OK
ABS light illuminated	OK	Service indicator light illuminated	OK