



**COMMERCIAL VEHICLE AUCTIONS LTD**  
THE UK'S MOST ESTABLISHED COMMERCIAL VEHICLE AUCTIONEERS

Carr Hill Industrial Estate  
Doncaster  
DN4 8DE

01302 732600 | cva.noreply@cva-auctions.co.uk

# VEHICLE INSPECTION REPORT

**BF23YOC**

## Iveco Eurocargo 120-210

Inspection		Vehicle	
Serious Damage?	No	VAT	Plus VAT
		V5	Present

Details			
Reg. date	08/06/2023	Colour	WHITE
Year	2023	VIN	ZCFAH1EF002729385
Mileage	68,190 Km Warranted	Body Style	Pole Erection Unit
Fuel Type	Diesel	Service history	Yes
		Service documents	Printout
		Gearbox	MANUAL
		Axle Combi	4x2
		Rear Suspension	Steel

PALFINGER PK 9.501 REMOTE CRANE (YEAR 2022), AUTOGUIDE 40PXV AUGER (YEAR 2022), POLE JACK, HEATED DRYING LOCKER, 240V POWER, AUGER EXTENSION POLE, SURROUND CAMERA SYSTEM

Tyres				
NSF	NSI1	NSI2	NSI3	NSI4
OSF	OSI1	OSI2	OSI3	OSI4
Spare	NSO1	NSO2	NSO3	NSO4
	OSO1	OSO2	OSO3	OSO4

## Features

- Bluetooth connection
- Cruise control
- Park assist camera
- Air conditioning
- Cloth seat trim

## Photos

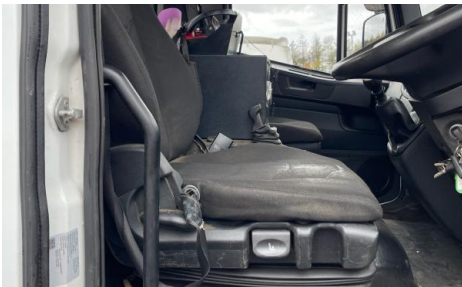

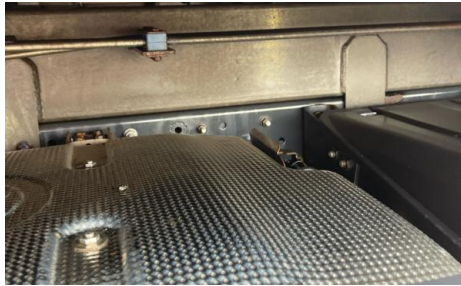



## Condition Check

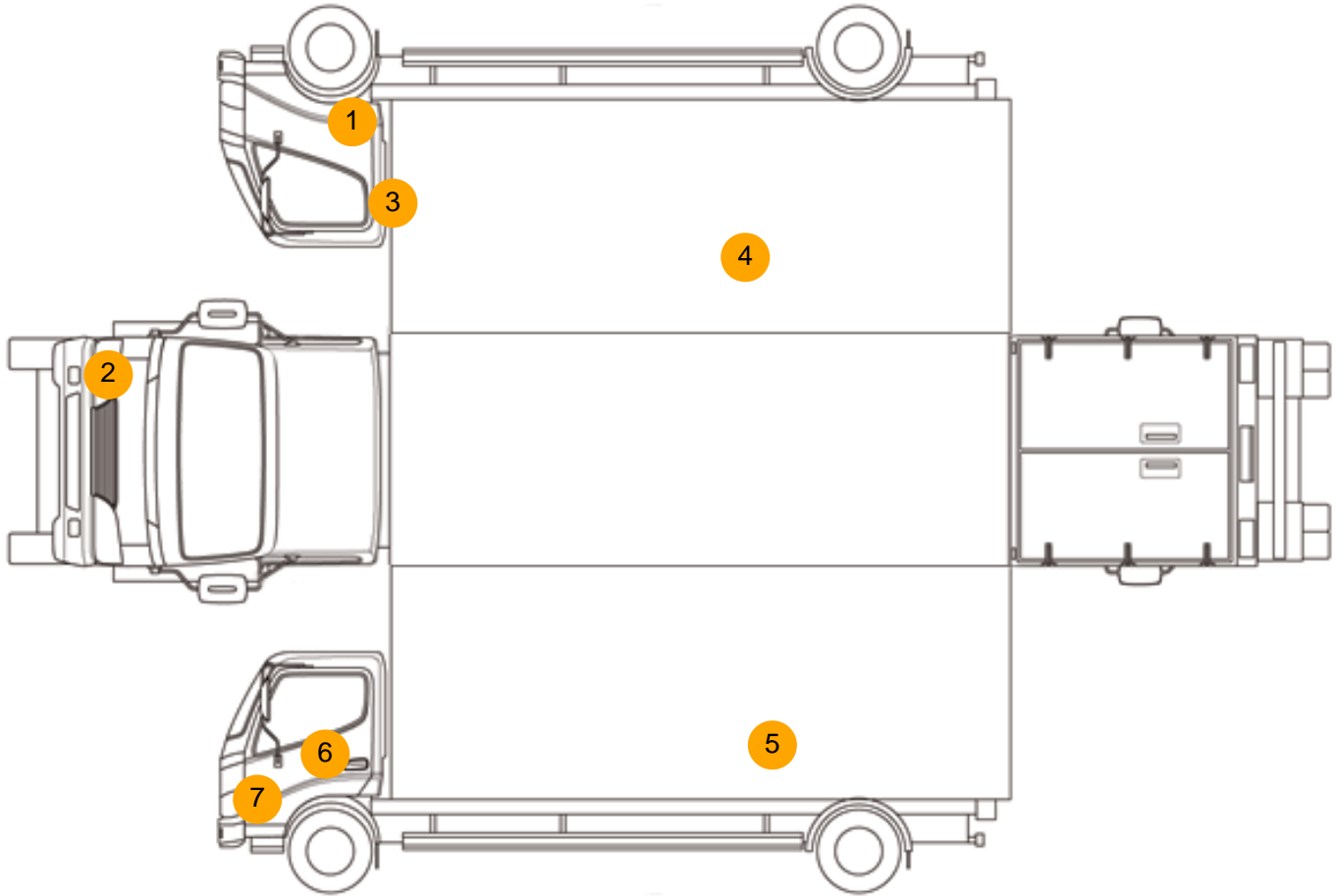

## Damage Photos

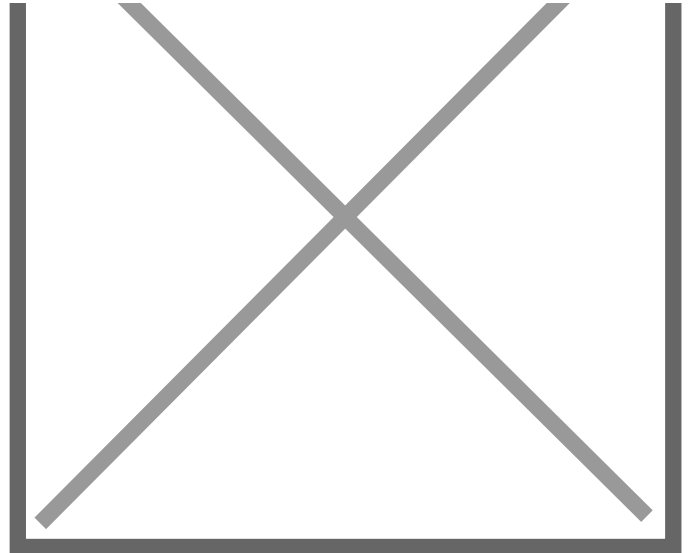
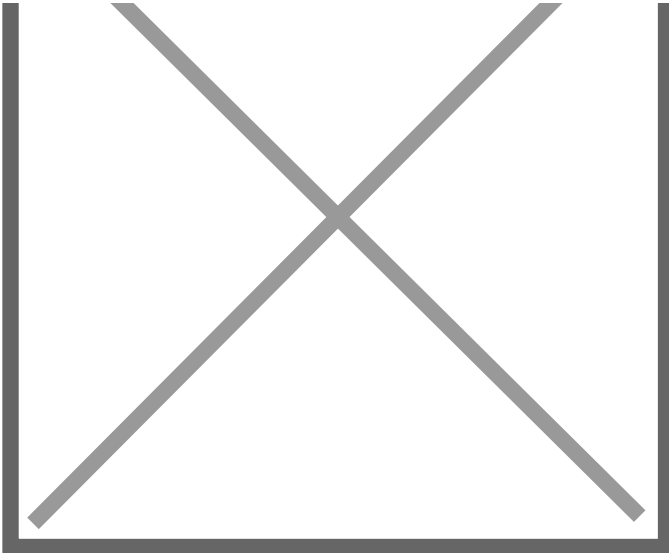

1: Door Moulding of  
Scuffed (Unpainted)  
Over 100mm

2: Bumper Front Moulding  
Scuffed (Unpainted)  
Up To 100mm

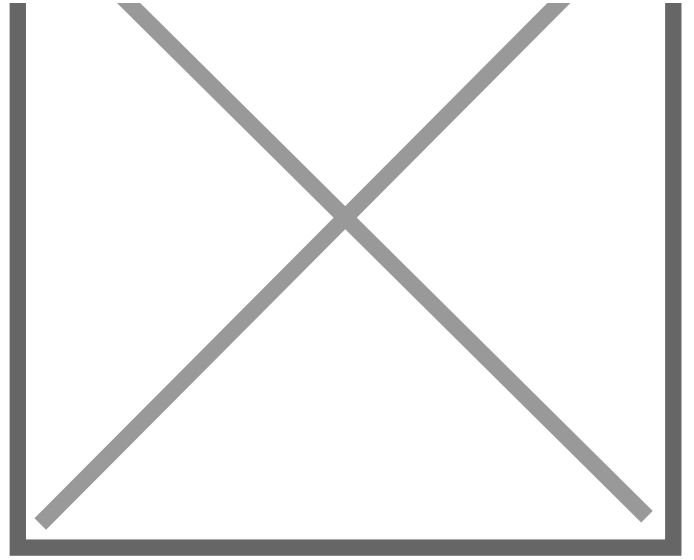
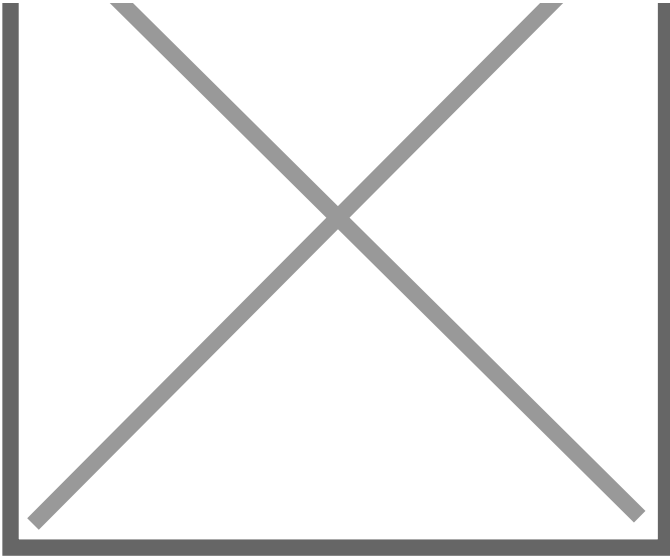

3: Door osf  
Dented  
Over 30mm

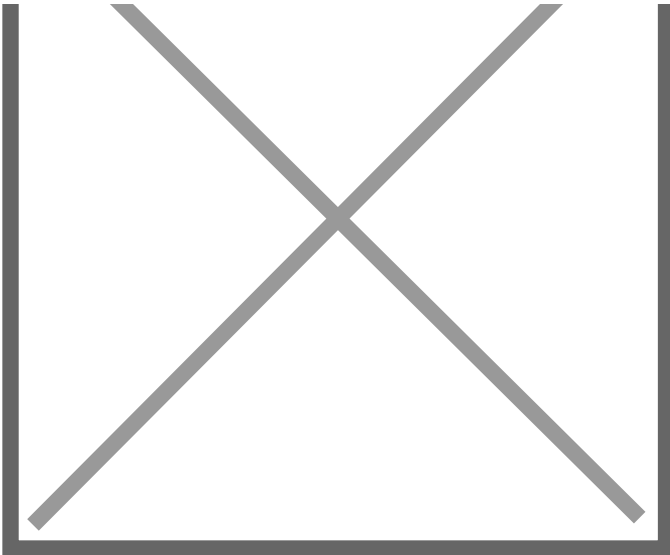

4: Qtr Panel osr  
Rusted  
Over 5mm

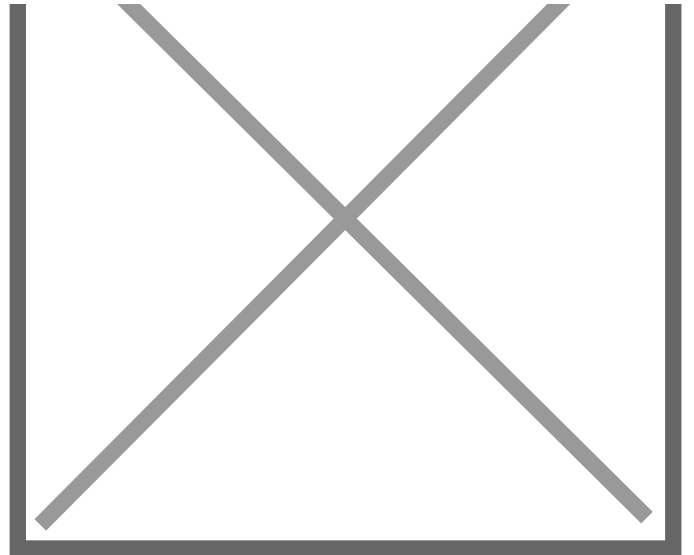

5: Qtr Panel nsr  
Scratched  
Over 25mm Thru Paint

6: Door nsf  
Dented  
Over 30mm

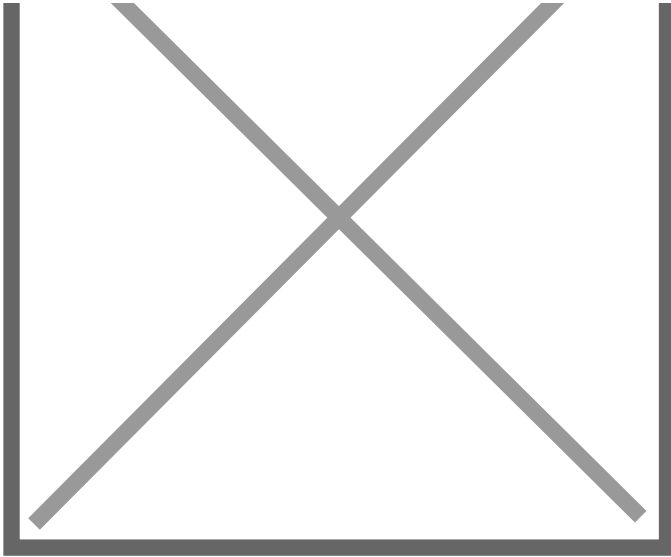

7: Wing nsf  
Chipped  
Over 5mm

#### Interior

<b>Carpet Condition</b>	Average		<b>Upholstery Condition</b>	Average
<b>Seat Condition</b>	Average		<b>Odour</b>	-
Engine Runs		OK	Gearbox 1st and Reverse Test	OK
Brakes		OK	Clutch Slip Test from Static	OK
Turbo Boosting		OK	Gearbox Static Gear Selection (engine running)	OK
Parking Brake		OK	No Excessive Smoking	OK
EML light illuminated		OK	Oil warning light illuminated	OK
Airbag light illuminated		OK	DPF light illuminated	OK
ABS light illuminated		OK	Service indicator light illuminated	OK
Windows		OK	Radio	OK
			Steering	OK