



COMMERCIAL VEHICLE AUCTIONS LTD
THE UK'S MOST ESTABLISHED COMMERCIAL VEHICLE AUCTIONEERS

Carr Hill Industrial Estate
Doncaster
DN4 8DE

01302 732600 | cva.noreply@cva-auctions.co.uk

VEHICLE INSPECTION REPORT

PO18RXZ

Daf CF 230

Inspection		Vehicle	
Serious Damage?	No	VAT	Plus VAT
		V5	To Follow

Details

Reg. date	09/05/2018	VIN	XLRAEM3700G184221	Axle Combi	4x2
Year	2018	Body Style	Curtainside	Rear Suspension	Air
Mileage	289,303 Km Warranted	MOT Due	30/04/2027	Rear Doors	Roller
Fuel Type	Diesel	Cab Type	DAY CAB	Tail Lift	Column
Colour	RED	Gearbox	AUTOMATIC		

SERVICE SCHEDULE LIST AVAILABLE, SURROUND CAMERA SYSTEM, T/LIFT TESTED 25/02/2026

Tyres

NSF	NSI1	NSI2	NSI3	NSI4
OSF	OSI1	OSI2	OSI3	OSI4
Spare	NSO1	NSO2	NSO3	NSO4
	OSO1	OSO2	OSO3	OSO4

Features

- Park assist camera
- Air conditioning
- Front electric windows

Photos



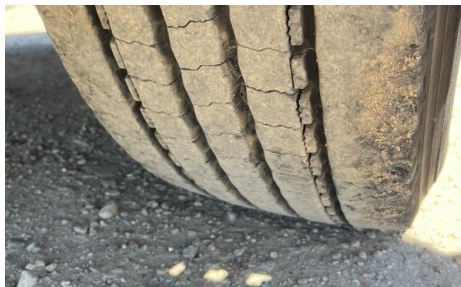
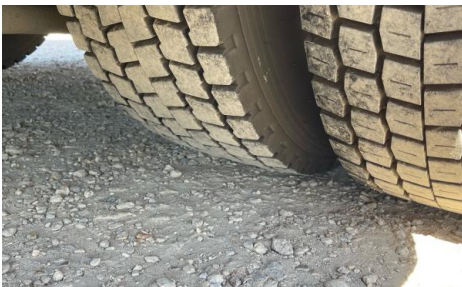
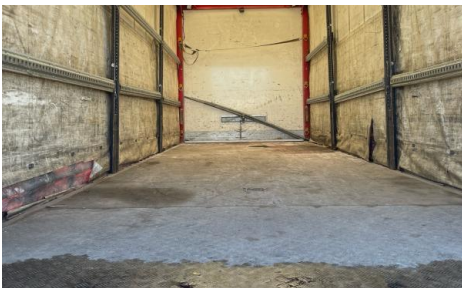
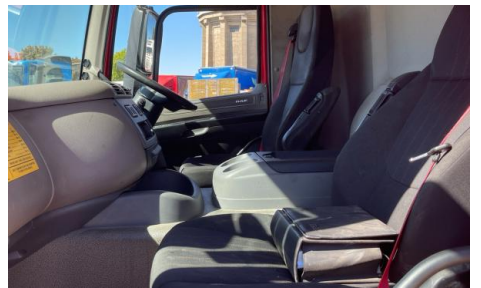
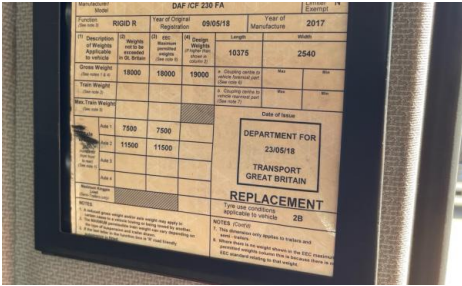

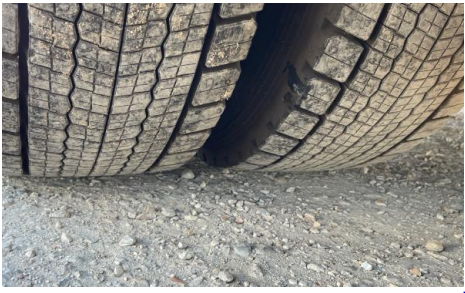

Condition Check

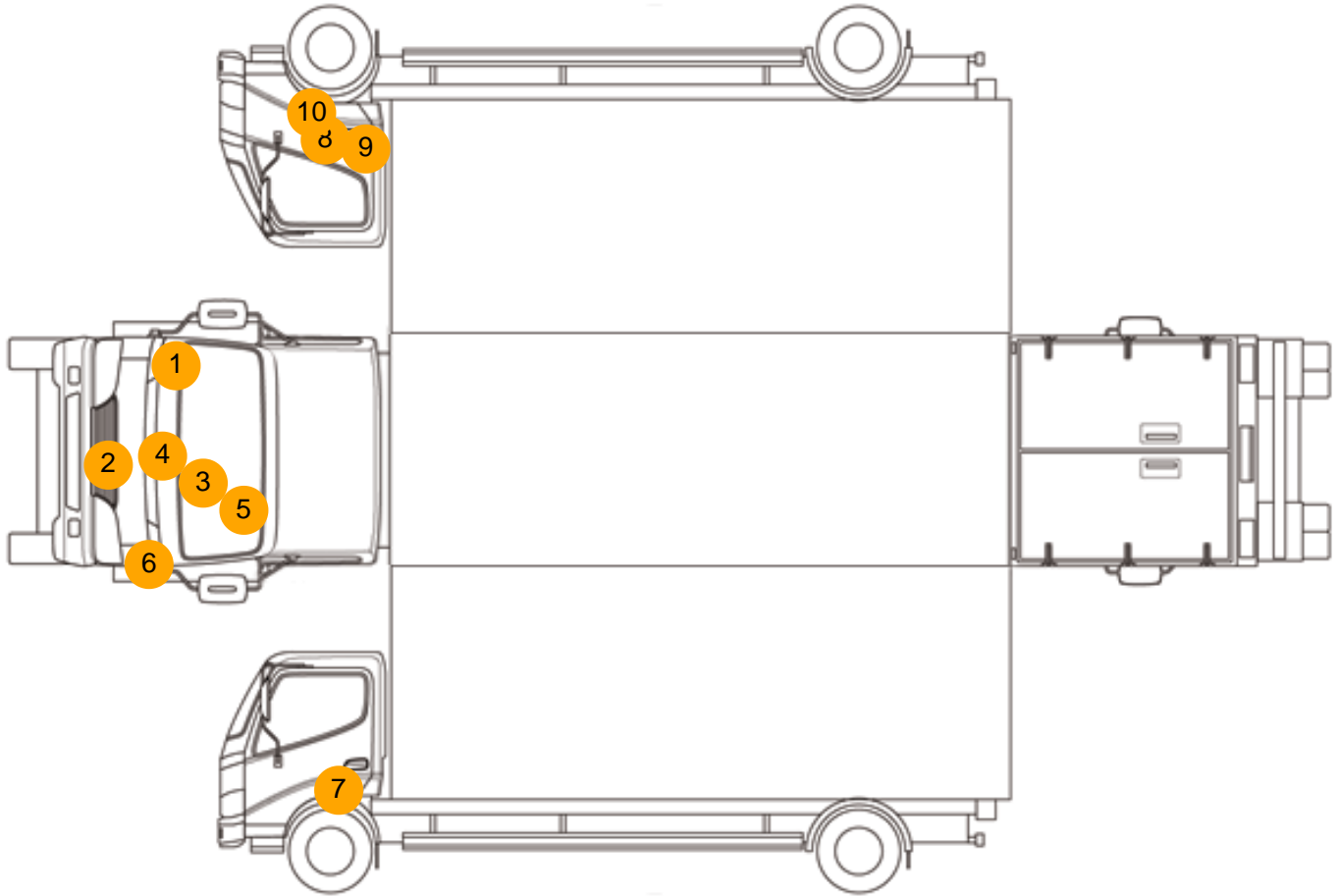

Damage Photos



1: Wing osf
Cracked
Replace



2: Bumper Front
Chipped
Multiple Chips



3: Bonnet
Chipped
Multiple Chips



4: Badgedecal Front
Missing
Replace



5: Screen Front
Chipped
Up To 10mm



6: Wing nsf
Cracked
Replace



7: Wing Front Arch Extension ns
Scuffed (Unpainted)
Over 100mm

8: Door osf
Dented
Between 10mm + 30mm



9: Door osf
Dented
Between 10mm + 30mm

10: Wing Front Arch Extension os
Scuffed (Unpainted)
Over 100mm



11: Switches And Controls
Broken
Replace

Interior

Carpet Condition	Average	Upholstery Condition	Average
Seat Condition	Average	Odour	-
Engine Runs	OK	Gearbox 1st and Reverse Test	OK
Brakes	OK	Clutch Slip Test from Static	OK
Parking Brake	OK	Gearbox Static Gear Selection (engine running)	OK
		No Excessive Smoking	OK
EML light illuminated	OK	Oil warning light illuminated	OK
Airbag light illuminated	OK	DPF light illuminated	OK
ABS light illuminated	OK	Service indicator light illuminated	OK