



COMMERCIAL VEHICLE AUCTIONS LTD
THE UK'S MOST ESTABLISHED COMMERCIAL VEHICLE AUCTIONEERS

Carr Hill Industrial Estate
Doncaster
DN4 8DE

01302 732600 | cva.noreply@cva-auctions.co.uk

VEHICLE INSPECTION REPORT

MT69EOG

Renault T 460

Inspection

Serious Damage? No

Vehicle

VAT Plus VAT

V5 Buyer To Apply

Details

Reg. date	01/11/2019	Colour	WHITE	Gearbox	AUTOMATIC
Year	2019	VIN	VF611C169LD005208	Axle Combi	6x2
Mileage	762,075 Km Not Warranted	Body Style	Tractor Unit	Steering Combi	Mid-Lift
Fuel Type	Diesel	MOT Due	31/08/2026	Rear Suspension	Air
GVW	44000kg	Cab Type	SLEEPER CAB		

WARNING LIGHTS ON DASH SLIDING 5TH WHEEL

Tyres

NSF	NSI1	NSI2	NSI3	NSI4
OSF	OSI1	OSI2	OSI3	OSI4
Spare	NSO1	NSO2	NSO3	NSO4
	OSO1	OSO2	OSO3	OSO4

Features

- Bluetooth connection
- Air conditioning
- Cruise control
- Front electric windows
- Digital radio
- Central locking
- Radio/CD
- Cloth seat trim

Photos



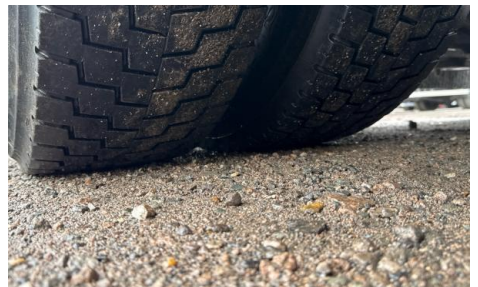
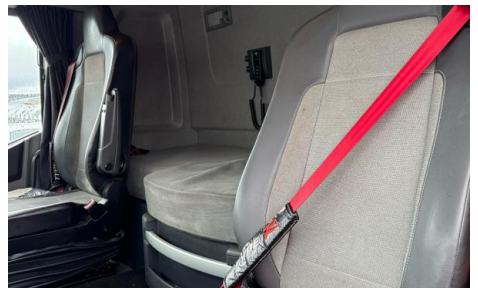
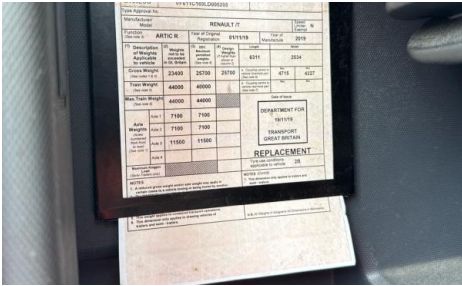
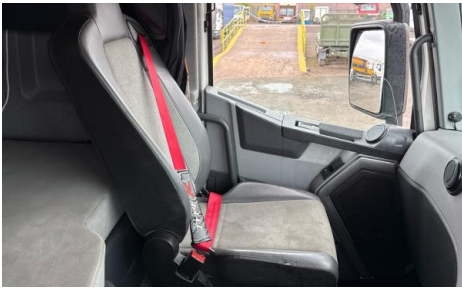

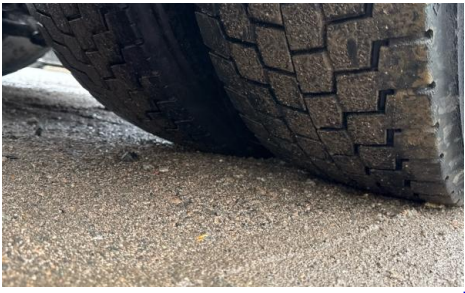

Condition Check

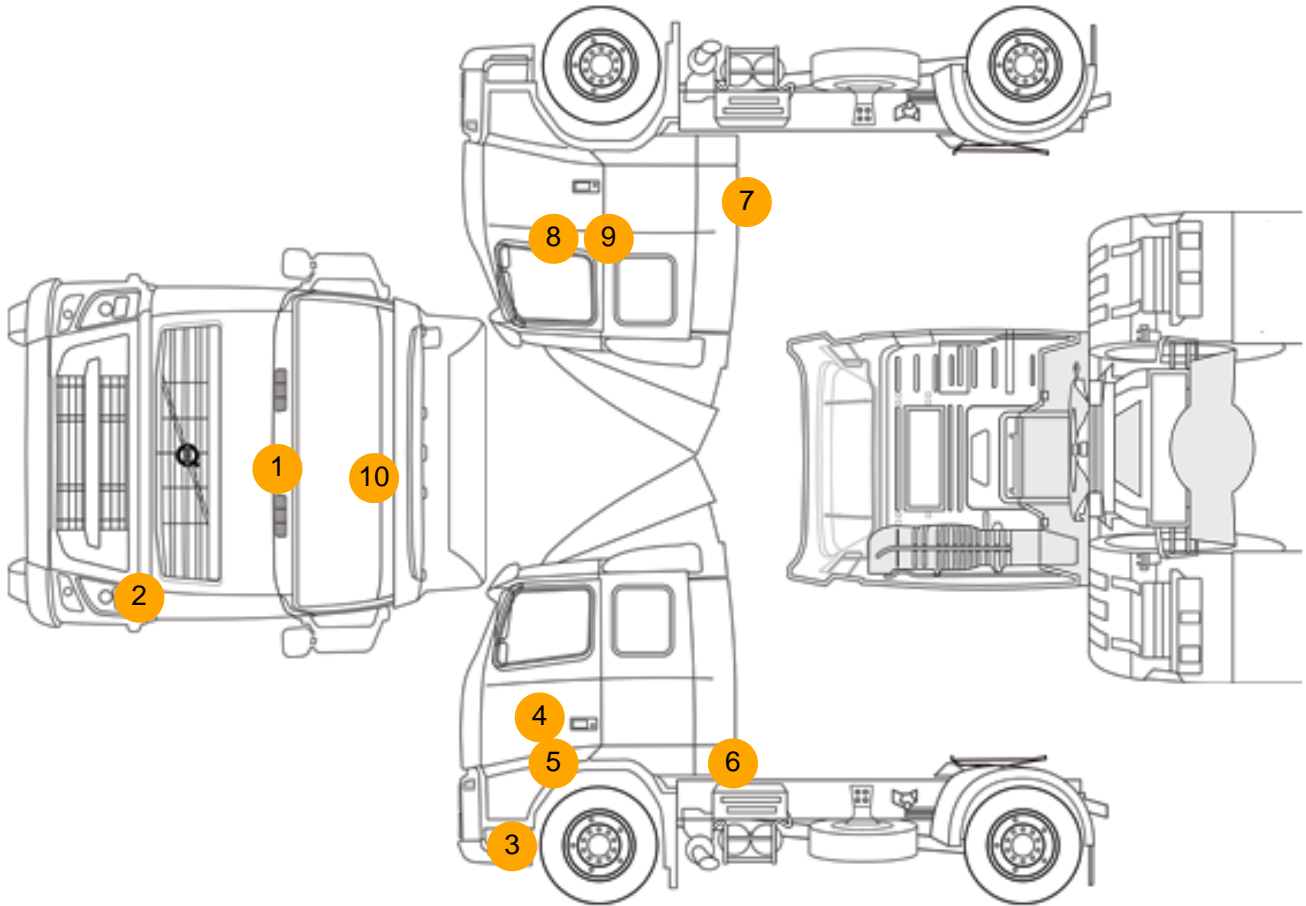

Damage Photos



1: Bonnet
Chipped
Multiple Chips



2: Bumper Front Moulding
Broken
Replace



3: Bumper Front Moulding
Scuffed (Unpainted)
Over 100mm

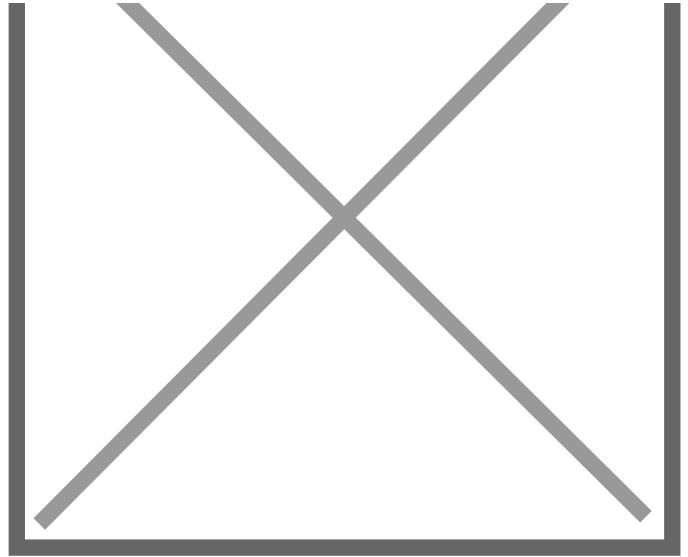

4: Door nsf
Scratched
Over 25mm Thru Paint

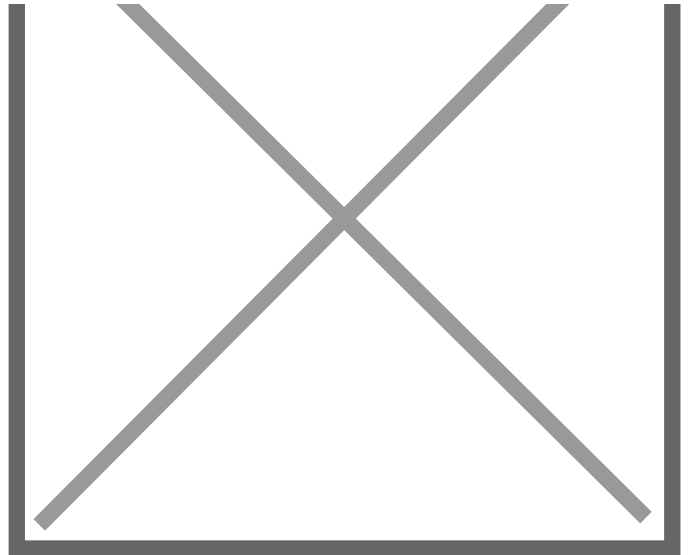

5: Door nsf
Dented
Over 30mm

6: Qtr Panel Trim ns
Broken
Replace

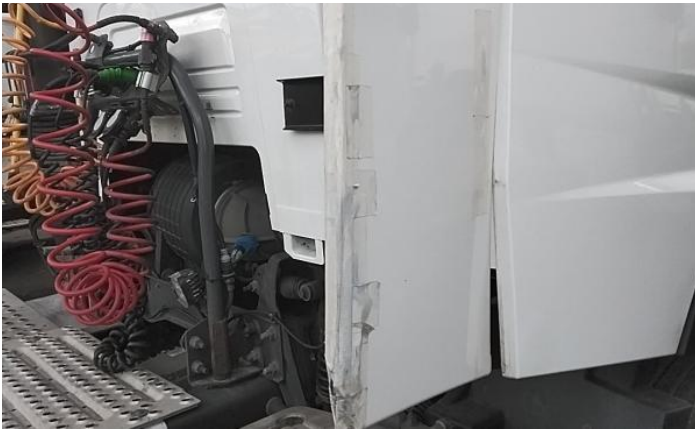

7: Qtr Panel Trim os
Broken
Replace

8: Door osf
Scratched
Over 25mm Thru Paint

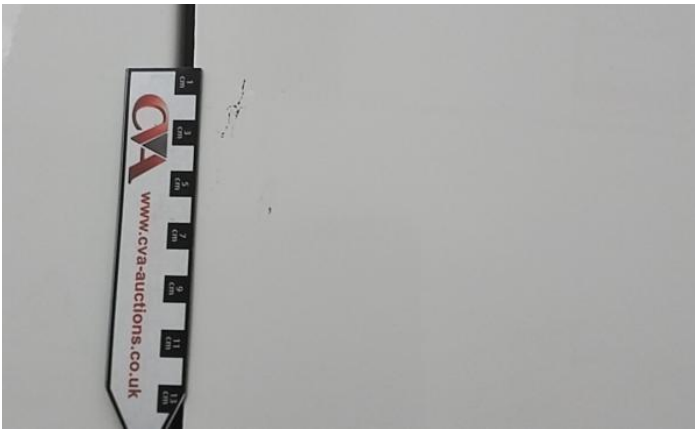

9: Door osf
Scratched
Over 25mm Thru Paint

10: Screen Front
Cracked
Replace



11: Door Pad osf
Soiled
Heavy

12: Seat Base Cover osf
Holed
Over 3mm



13: Seat Base Cover nsf
Soiled
Heavy

14: Dash Warning Lights
Displayed
No Action

Interior

Carpet Condition

OK

Upholstery Condition

Poor

Seat Condition

Poor

Odour

-

Engine Runs	OK	No Excessive Smoking	OK
EML light illuminated	Fault	DPF light illuminated	Fault
ABS light illuminated	Fault		