



COMMERCIAL VEHICLE AUCTIONS LTD
THE UK'S MOST ESTABLISHED COMMERCIAL VEHICLE AUCTIONEERS

Carr Hill Industrial Estate
Doncaster
DN4 8DE

01302 732600 | cva.noreply@cva-auctions.co.uk

VEHICLE INSPECTION REPORT

YF19FRL

Ford Transit Custom 320 2.0 TDCI 130PS

Inspection		Vehicle	
Serious Damage?	No	VAT	Plus VAT
		V5	Present

Details					
Reg. date	19/07/2019	Colour	WHITE	CAP Average	£6,350.00
Year	2019	VIN	WFOYXXTTGYKE26594	CAP Below	£4,950.00
Mileage	92,243 Miles Warranted	Body Style	Panel Van L2	Gearbox	MANUAL
Fuel Type	Diesel	MOT Due	Expired	Gears	6
GVW	3200kg	CAP Clean	£7,325.00	Axle Combi	4x2

COLLECTED AS NON-RUNNER - INJECTOR ISSUE AD-BLUE, SIDE LOAD DOOR, E/MIRRORS, HEATED WINDSCREEN

Tyres	
NSF	
NSR	
OSF	
OSR	
Spare	

Features

- Bluetooth connection
- Cruise control
- Front parking sensor
- Park assist camera
- Rear parking sensor
- Radio/CD
- Air conditioning
- Front electric windows
- Drivers airbag
- Passenger airbag
- Central locking
- Cloth seat trim

Photos



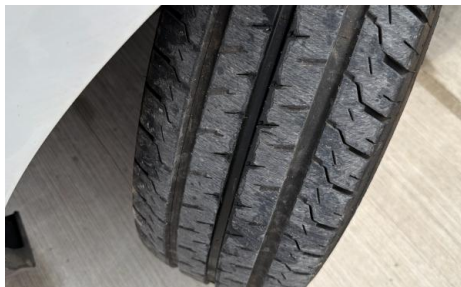
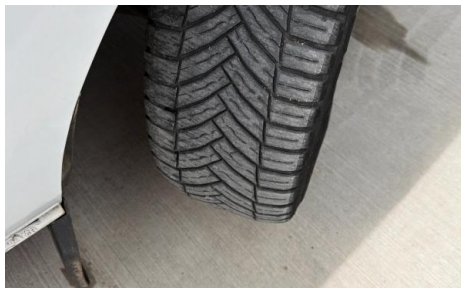
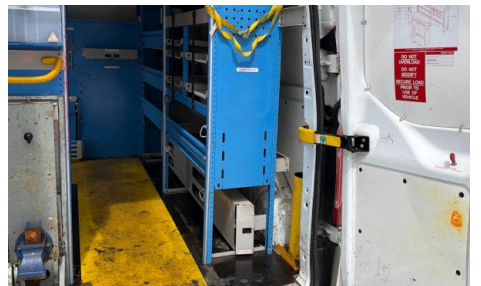
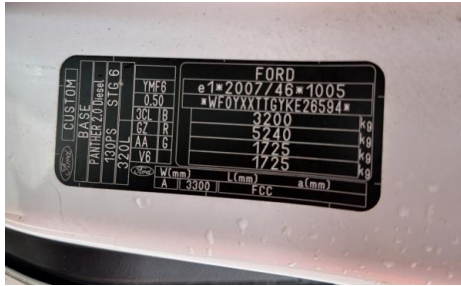

Condition Check

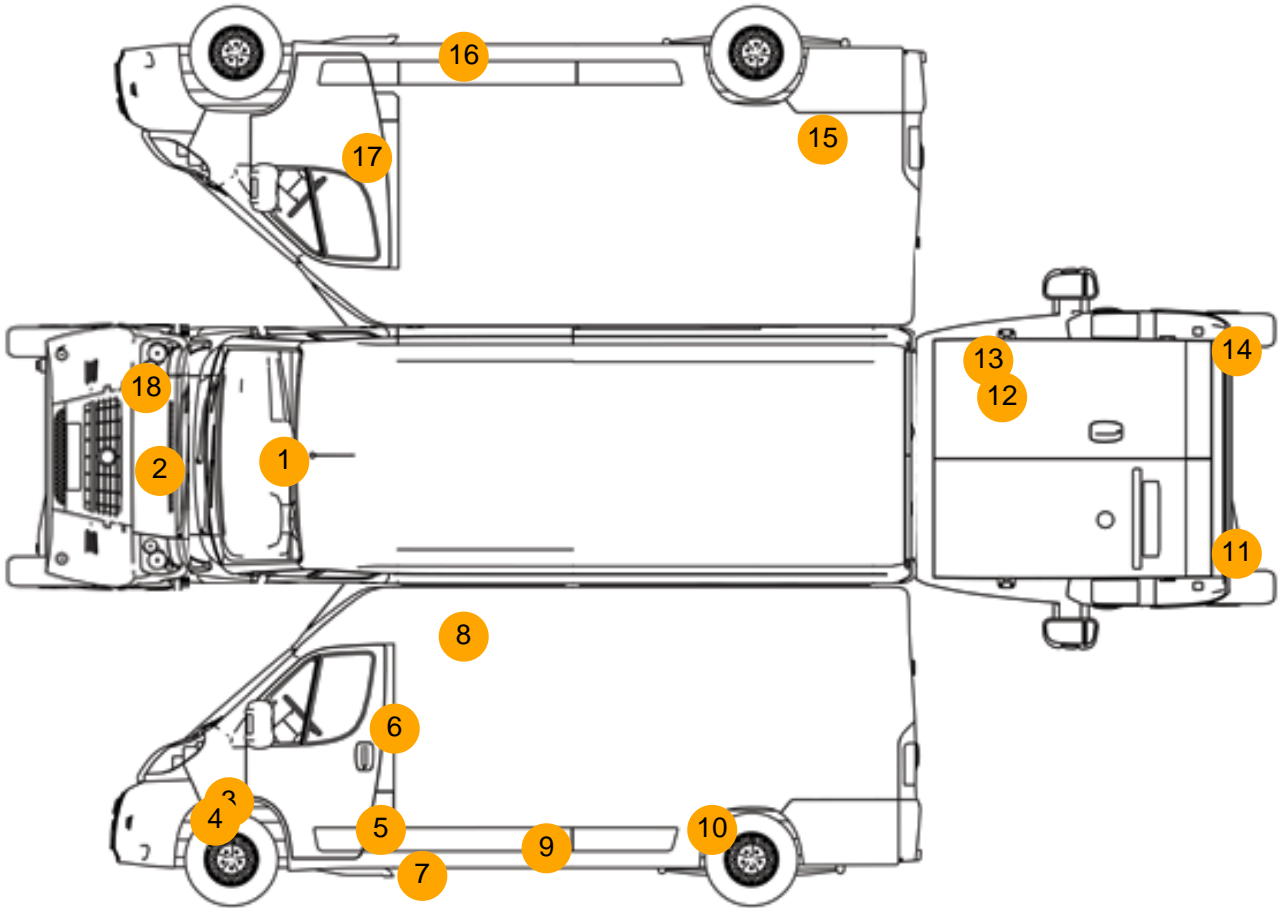

Damage Photos



1: Screen Front
Cracked
Replace

2: Bonnet
Chipped
Multiple Chips



3: Wing nsf
Chipped
Over 5mm

4: Bumper Front
Scratched
25 to 100mm Thru Paint

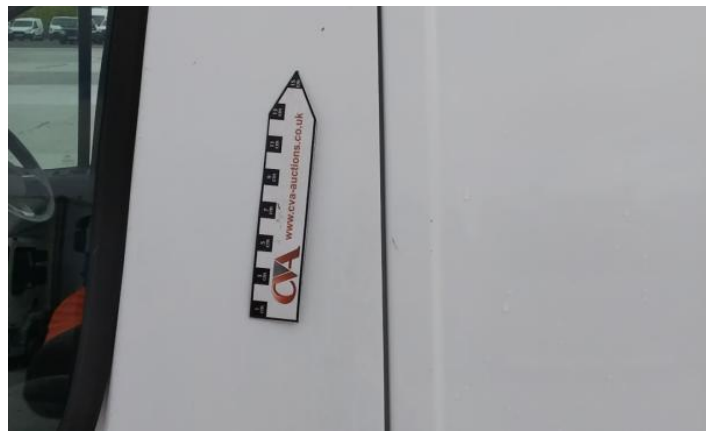

5: Door nsf
Dented
With Paint Damage

6: Door nsf
Chipped
Multiple Chips



7: Sill ns
Dented
Over 30mm

8: Qtr Panel nsr
Dented
With Paint Damage



9: Qtr Panel Moulding ns
Missing
Replace

10: Qtr Panel nsr
Dented
Hail - Severe



11: Bumper Rear
Insecure
Action Required

12: Door nsr
Dented
With Paint Damage



13: Qtr Panel Moulding os
Scratched (Painted)
Over 25mm Thru Paint

14: Bumper Rear
Insecure
Action Required



15: Qtr Panel osr
Chipped
Over 5mm

16: Sill os
Dented
Over 30mm



17: Door osf
Chipped
Multiple Chips

18: Bumper Front
Chipped
Multiple Chips

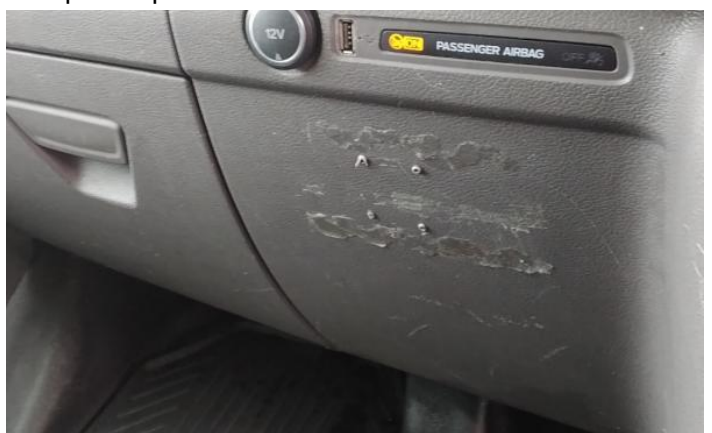

19: Seat Base Cover osf
Holed
Over 3mm

20: Centre Console Front
Holed
Over 3mm

Interior

Carpet Condition	OK	Upholstery Condition	OK
Seat Condition	OK	Odour	-
Engine Runs	OK	Gearbox 1st and Reverse Test	OK
Brakes	OK	Gearbox Static Gear Selection (engine running)	OK
Turbo Boosting	OK		
Parking Brake	OK		
EML light illuminated	OK	Service indicator light illuminated	OK
ABS light illuminated	OK		