



**COMMERCIAL VEHICLE AUCTIONS LTD**  
THE UK'S MOST ESTABLISHED COMMERCIAL VEHICLE AUCTIONEERS

Carr Hill Industrial Estate  
Doncaster  
DN4 8DE

01302 732600 | cva.noreply@cva-auctions.co.uk

# VEHICLE INSPECTION REPORT

**KP19SNB**

## Mercedes-Benz Sprinter 314 CDI

Inspection		Vehicle	
Serious Damage?	No	VAT	Plus VAT
		V5	Present

### Details

Reg. date	29/08/2019	Colour	WHITE	CAP Average	£7,125.00
Year	2019	VIN	WDB9076332P131328	CAP Below	£5,575.00
Mileage	147,038 Miles Not Warranted	Body Style	Panel Van L2	Gearbox	MANUAL
Fuel Type	Diesel	MOT Due	28/10/2026	Gears	6
GVW	3500kg	CAP Clean	£8,275.00		

\*WARNING LIGHTS ON DASH\* AD BLUE, SIDE LOADING DOOR

### Tyres

NSF	
NSR	
OSF	
OSR	
Spare	

### Features

- Rear parking sensor
- Front electric windows

### Photos



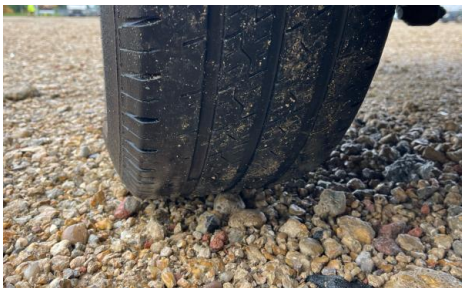
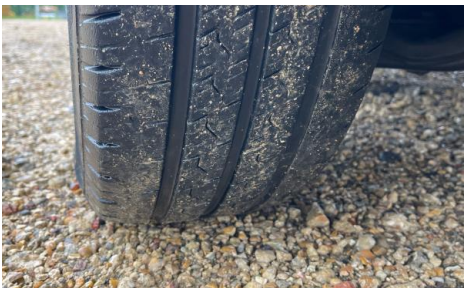
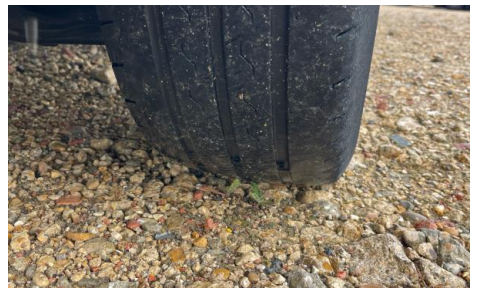
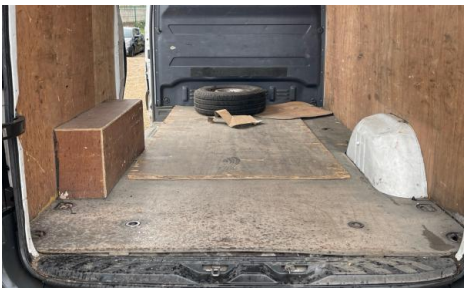

## Condition Check

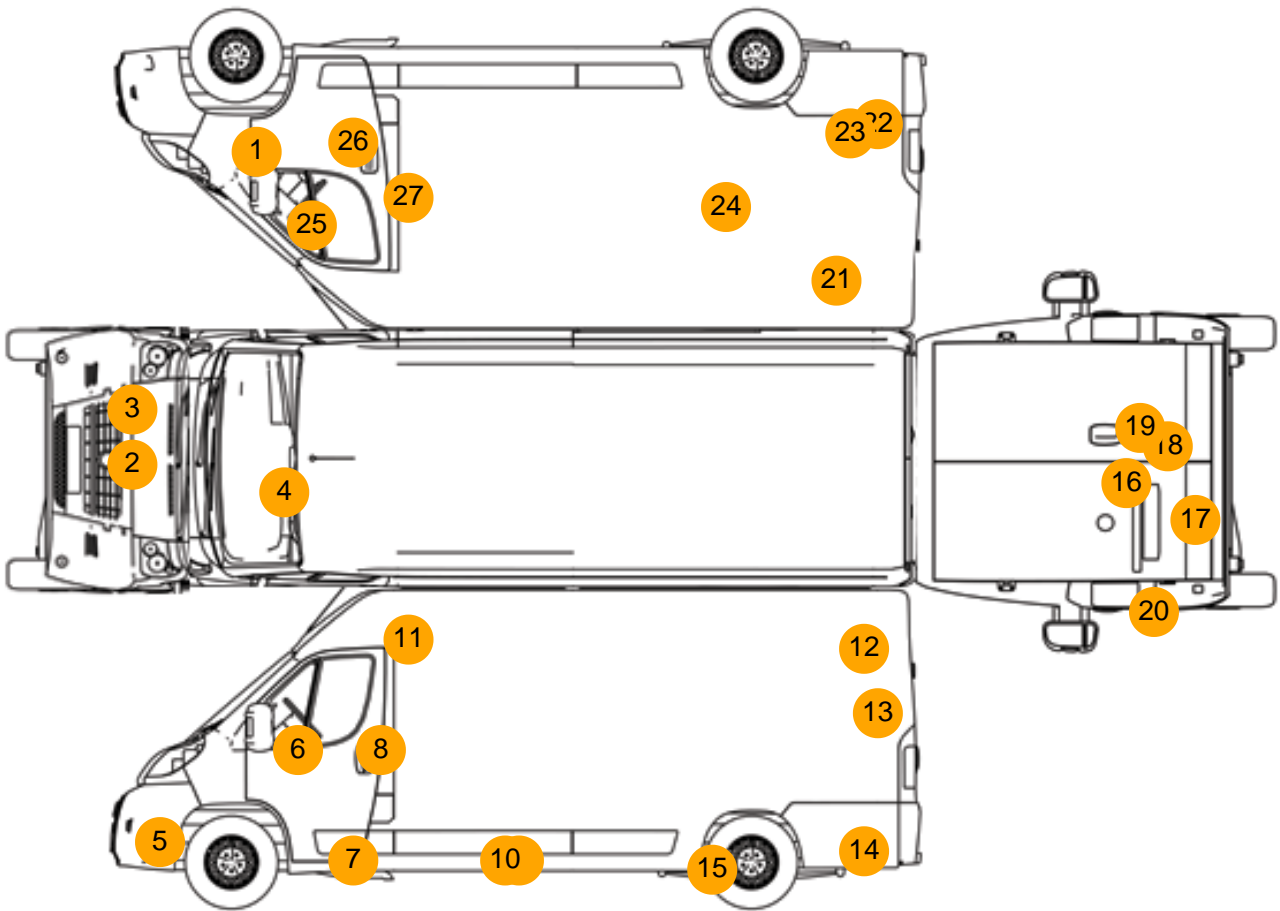

## Damage Photos



1: Wing Front Arch Extension os  
Missing  
Replace



2: Bumper Front  
Insecure  
Action Required



3: Bumper Front  
Insecure  
Action Required



4: Screen Front  
Chipped  
Over 10mm



5: Bumper Front Moulding  
Scuffed (Unpainted)  
Over 100mm

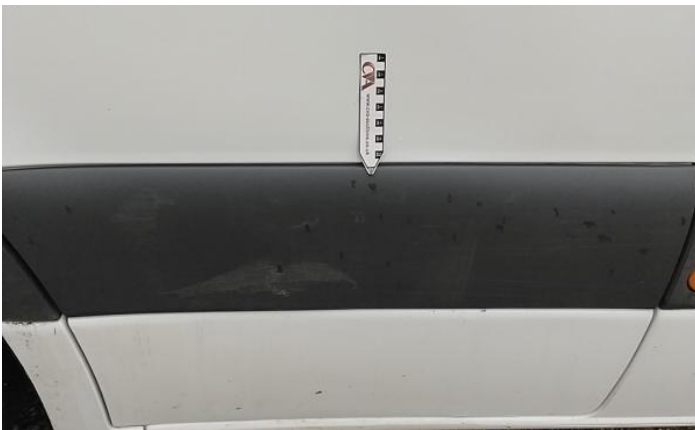

6: Door Mirror Assy nsf  
Scuffed (Unpainted)  
Over 100mm



7: Door Moulding nsf  
Scuffed (Unpainted)  
Over 100mm

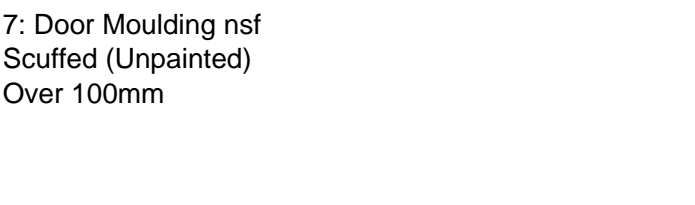

8: Door nsf  
Scratched  
Over 25mm Not Thru Paint

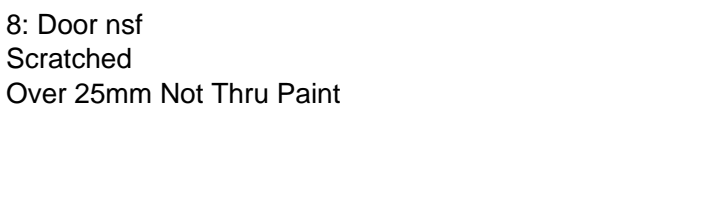



9: Door Moulding nsr  
Scuffed (Unpainted)  
Over 100mm



10: Door nsr  
Dented  
With Paint Damage



11: Roof  
Dented  
With Paint Damage



12: Roof  
Dented  
With Paint Damage



13: Qtr Panel nsr  
Scratched  
Over 25mm Not Thru Paint



14: Qtr Panel Moulding ns  
Scuffed (Unpainted)  
Over 100mm



15: Qtr Panel Moulding ns  
Scuffed (Unpainted)  
Over 100mm

16: Badgedecal Rear  
Broken  
Replace



17: Door nsr  
Dented  
With Paint Damage

18: Door osr  
Dented  
With Paint Damage



19: Door osr  
Scratched  
Over 25mm Thru Paint

20: Lamp nsr  
Broken  
Replace



21: Qtr Panel osr  
Scratched  
Over 25mm Not Thru Paint

22: Qtr Panel Trim os  
Scuffed  
Over 25mm



23: Qtr Panel osr  
Dented  
With Paint Damage

24: Qtr Panel osr  
Scratched  
Over 25mm Thru Paint



25: Door Mirror Assy osf  
Scuffed (Unpainted)  
UpTo 100mm

26: Door osf  
Scratched  
Over 25mm Thru Paint



27: Door osf  
 Scratched  
 Over 25mm Not Thru Paint

28: Seat Base Cover osf  
 Holed  
 Over 3mm



29: Steering Wheel  
 Damaged  
 Replace

**Interior**

Carpet Condition	Average	Upholstery Condition	Average
Seat Condition	Average	Odour	No
Engine Runs	OK	Gearbox 1st and Reverse Test	OK
Brakes	OK	Clutch Slip Test from Static	OK
Parking Brake	OK	Gearbox Static Gear Selection (engine running)	OK
		No Excessive Smoking	OK
EML light illuminated	Fault	Oil warning light illuminated	OK
Airbag light illuminated	Fault	DPF light illuminated	OK
ABS light illuminated	Fault	Service indicator light illuminated	Fault