



COMMERCIAL VEHICLE AUCTIONS LTD
THE UK'S MOST ESTABLISHED COMMERCIAL VEHICLE AUCTIONEERS

Carr Hill Industrial Estate
Doncaster
DN4 8DE

01302 732600 | cva.noreply@cva-auctions.co.uk

VEHICLE INSPECTION REPORT

BL64UUV

Mercedes-Benz Actros 1840

Inspection

Serious Damage? No

Vehicle

VAT Plus VAT

V5 To Follow

Details

Reg. date 04/02/2015

Year 2015

Mileage 1,151,581 Km
Warranted

Fuel Type Diesel

GVW 28000kg

Colour WHITE

VIN WDB9634032L922514

Body Style Tractor Unit

MOT Due 31/07/2026

Cab Type CLASSICSPACE CAB

Gearbox AUTOMATIC

Axle Combi 4x2

Rear Suspension Air

SURROUND CAMERA SYSTEM

Tyres

NSF NSI1

NSI2

NSI3

NSI4

OSF OSI1

OSI2

OSI3

OSI4

Spare NSO1

NSO2

NSO3

NSO4

OSO1

OSO2

OSO3

OSO4

Features

- Air conditioning

Photos

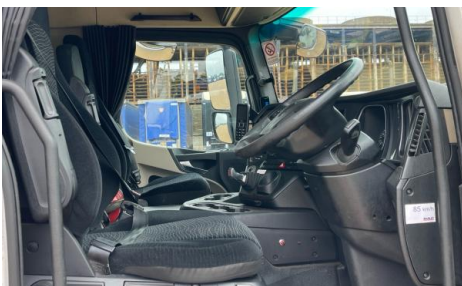

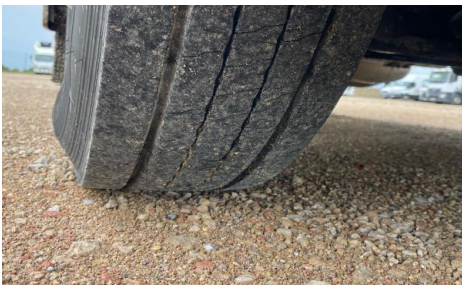
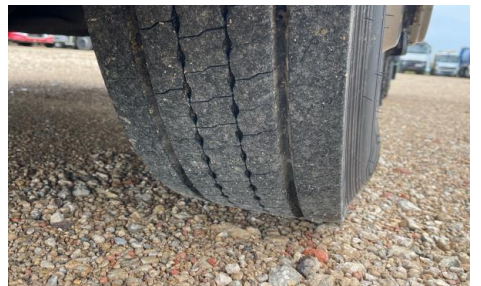
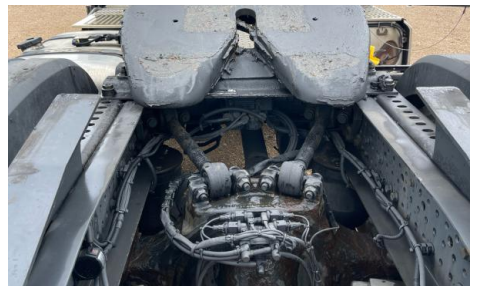
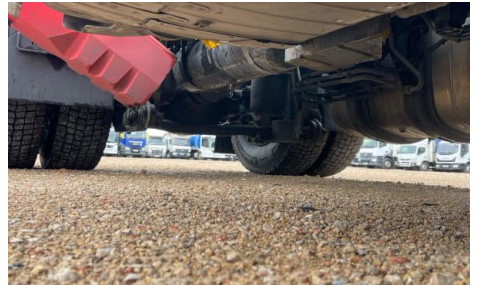
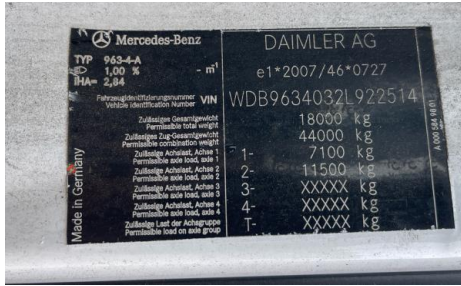

Condition Check

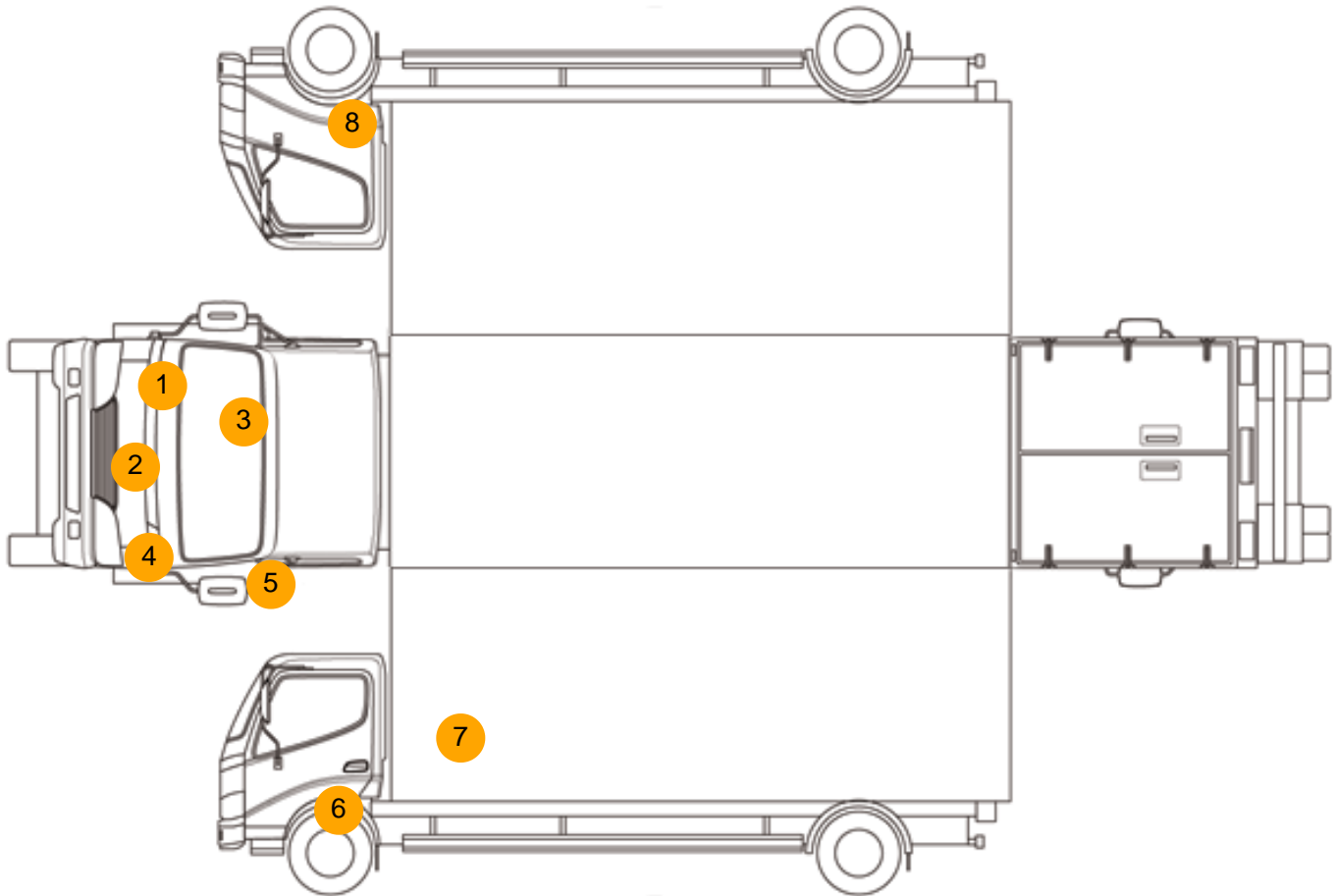

Damage Photos



1: Wing of
Scratched
Over 25mm Not Thru Paint

2: Bumper Front
Chipped
Multiple Chips



3: Screen Front
Chipped
Over 10mm

4: Bumper Front Moulding
Scuffed (Unpainted)
Up To 100mm



5: Door Mirror Assy nsf
Scuffed (Unpainted)
Over 100mm

6: Wing Front Arch Extension ns
Scratched (Painted)
Over 25mm Thru Paint



7: Qtr Panel nsr
Cracked
Replace

8: Wing Front Arch Extension os
Scratched (Painted)
Over 25mm Thru Paint



9: Carpets Front
 Holed
 Over 3mm

Interior

Carpet Condition	Average	Upholstery Condition	Average
Seat Condition	Average	Odour	-
Engine Runs	OK	Gearbox 1st and Reverse Test	OK
Brakes	OK	Clutch Slip Test from Static	OK
Parking Brake	OK	Gearbox Static Gear Selection (engine running)	OK
		No Excessive Smoking	OK
EML light illuminated	OK	Oil warning light illuminated	OK
Airbag light illuminated	OK	DPF light illuminated	OK
ABS light illuminated	OK	Service indicator light illuminated	OK