



COMMERCIAL VEHICLE AUCTIONS LTD
THE UK'S MOST ESTABLISHED COMMERCIAL VEHICLE AUCTIONEERS

Carr Hill Industrial Estate
Doncaster
DN4 8DE

01302 732600 | cva.noreply@cva-auctions.co.uk

VEHICLE INSPECTION REPORT

LN67WWD

Ford Transit 350 2.0 TDCi 130ps

Inspection		Vehicle	
Serious Damage?	No	VAT	Plus VAT
		V5	Present

Details

Reg. date	30/09/2017	Colour	GREEN	CAP Average	£3,100.00
Year	2017	VIN	WF0XXXTTGXHB69876	CAP Below	£2,300.00
Mileage	130,835 Miles Warranted	Body Style	Panel Van L3	Gearbox	MANUAL
Fuel Type	Diesel	MOT Due	29/09/2026	Gears	6
GVW	3500kg	CAP Clean	£3,750.00		

WARNING LIGHT ON DASH AD-BLUE

Tyres

NSF
NSR
OSF
OSR
Spare

Features

- Bluetooth connection
- Digital radio
- Cloth seat trim
- Park assist camera
- Front electric windows
- Rear parking sensor
- Drivers airbag
- Auxiliary input socket
- Central locking

Photos

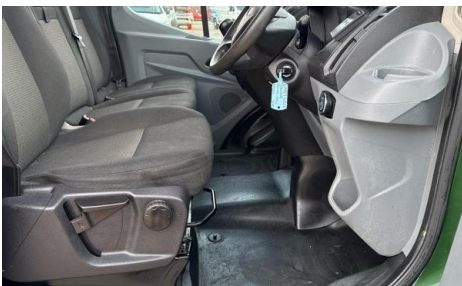

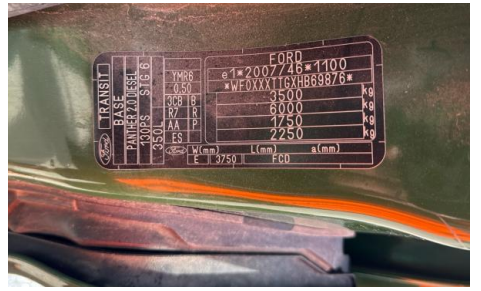
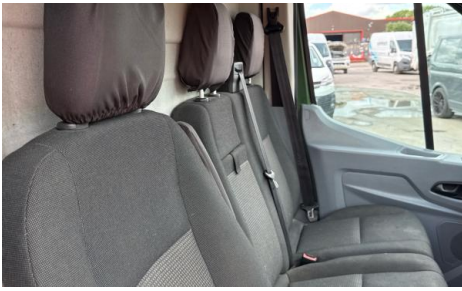

FORD		
e1*2007746*1100		
AWEDXX116YH883876*		
kg	3500	
kg	6000	
kg	7750	
kg	2250	
W(mm)	L(mm)	a(mm)
E	3750	FCD

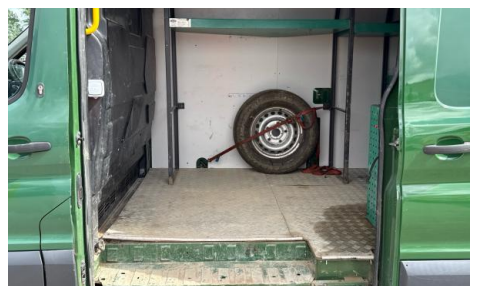
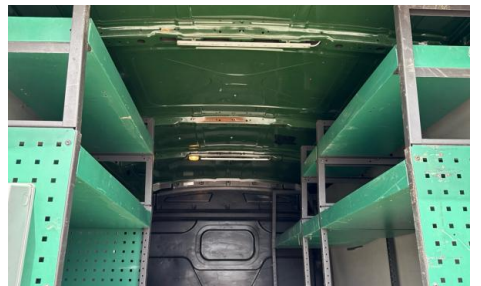
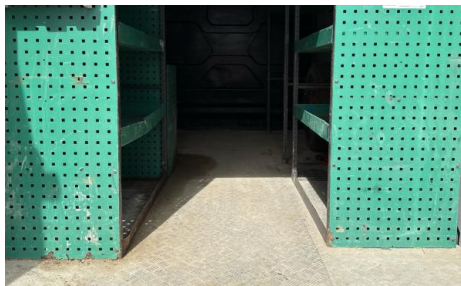



Condition Check

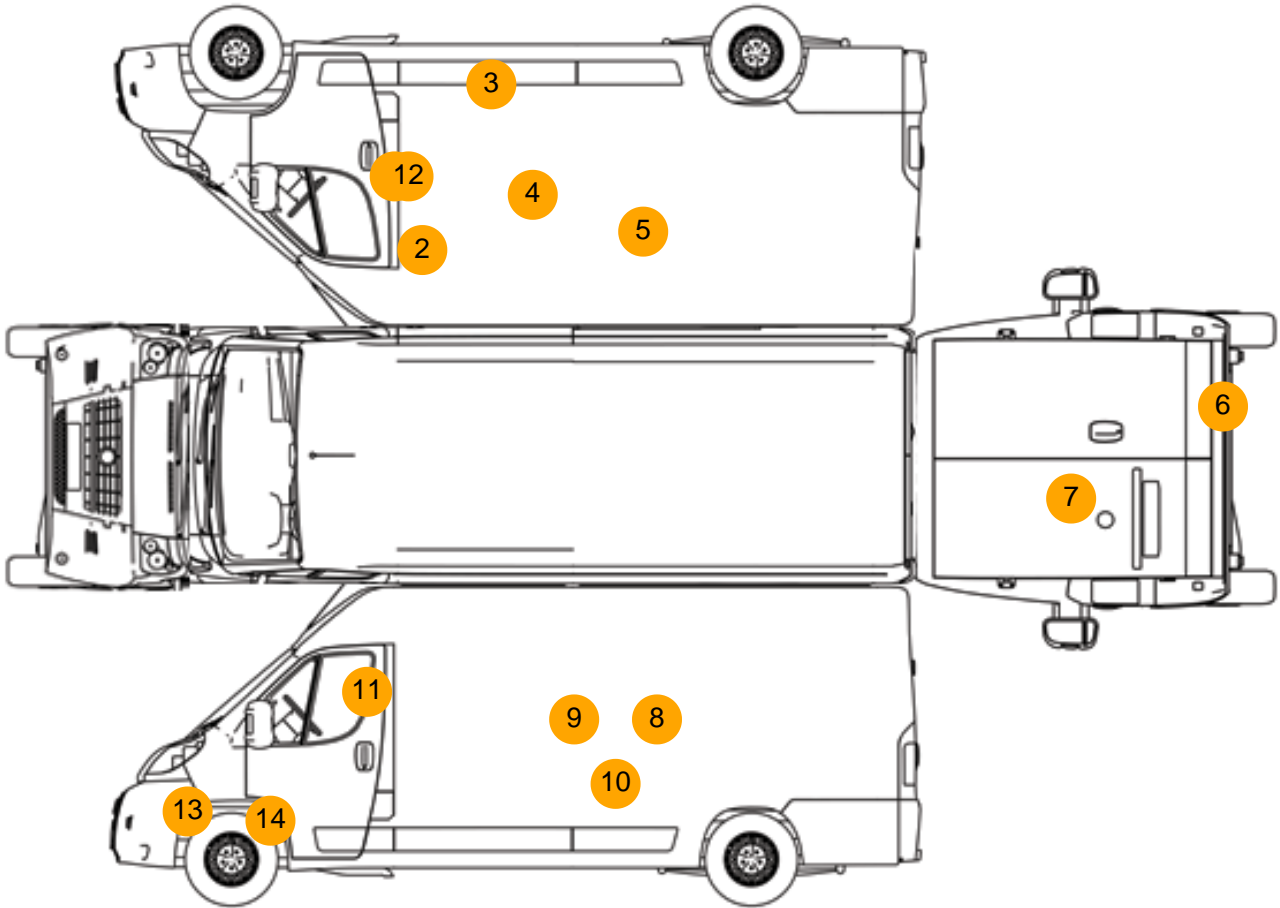

Damage Photos



1: Door osf
Chipped
Edge Chip

2: Door osf
Chipped
Edge Chip



3: Sill os
Scratched
UpTo 25mm Not Thru Paint

4: Panel Rear
Scratched
Over 25mm Not Thru Paint



5: Panel Rear
Chipped
Over 5mm

6: Tailgate Trim Panel
Scuffed (Unpainted)
Over 100mm



7: Door nsr
Dented
With Paint Damage

8: Door nsr
Chipped
Multiple Chips

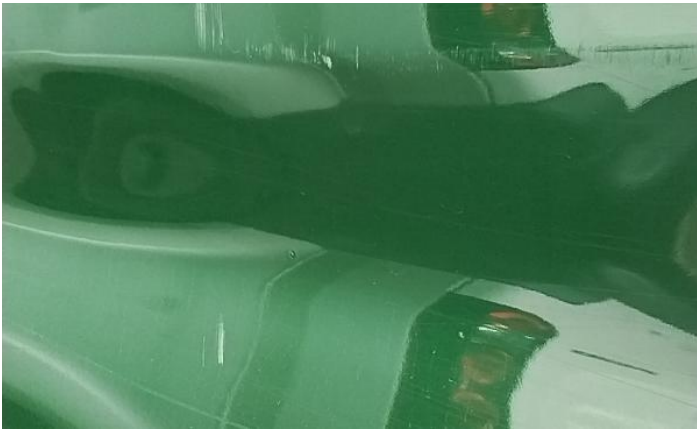

9: Door nsr
Scratched
Over 25mm Thru Paint

10: Door nsr
Scratched
Over 25mm Not Thru Paint



11: Door nsf
Chipped
Edge Chip

12: Door nsf
Chipped
Edge Chip



13: Bumper Front Moulding
Scuffed (Unpainted)
Over 100mm

14: Moulding nsf Wing
Broken
Replace

Interior

Carpet Condition	OK	Upholstery Condition	OK
Seat Condition	Average	Odour	No
Engine Runs	OK	Gearbox 1st and Reverse Test	OK
Brakes	OK	Clutch Slip Test from Static	OK
Turbo Boosting	OK	Gearbox Static Gear Selection (engine running)	OK
Parking Brake	OK	No Excessive Smoking	OK
EML light illuminated	Fault	Oil warning light illuminated	OK
Airbag light illuminated	OK	DPF light illuminated	OK
ABS light illuminated	OK	Service indicator light illuminated	OK
Windows	OK	Radio	OK
		Steering	OK