



**COMMERCIAL VEHICLE AUCTIONS LTD**  
THE UK'S MOST ESTABLISHED COMMERCIAL VEHICLE AUCTIONEERS

Carr Hill Industrial Estate  
Doncaster  
DN4 8DE

01302 732600 | cva.noreply@cva-auctions.co.uk

# VEHICLE INSPECTION REPORT

**A162474**

## Volvo B9R Plaxton Panther

Inspection		Vehicle	
Serious Damage?	No	VAT	Plus VAT
		V5	Buyer To Apply

### Details

Reg. date		Colour		Cab Type	DAY CAB
Year		VIN	YV3S5P723DA162474	Gearbox	AUTOMATIC
Mileage	311,374 Km Warranted	Body Style	Coach	Axle Combi	4x2
Fuel Type		MOT Due	30/09/2026	Rear Suspension	Air

**\*5% BUYERS FEE\* 53 SEATS + DRIVER, \* TENDER ENDING 27TH MAY\*\***  
RECLINING SEATS WITH FOOTRESTS, 3 PT SEATBELTS, OVER HEAD STOWAGE, REAR EMERGENCY EXIT, FULL WIDTH UNDER BODY STORAGE, MOD654 FORM IN OFFICE, TWIN FUEL TANKS

### Tyres

NSF	NSI1	NSI2	NSI3	NSI4
OSF	OSI1	OSI2	OSI3	OSI4
Spare	NSO1	NSO2	NSO3	NSO4
	OSO1	OSO2	OSO3	OSO4

## Features

- Bluetooth connection
- Digital radio
- Cruise control
- Radio/CD
- Park assist camera
- Air conditioning
- Auxilliary input socket
- Leather seat trim

## Photos



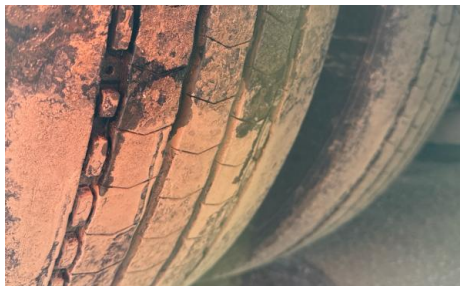
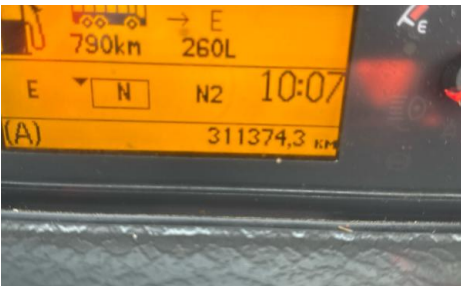
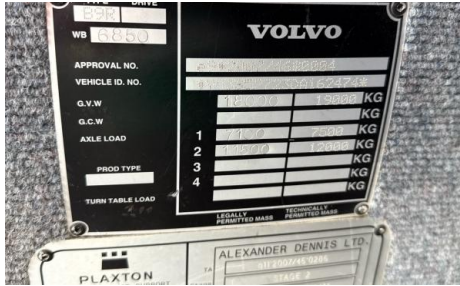
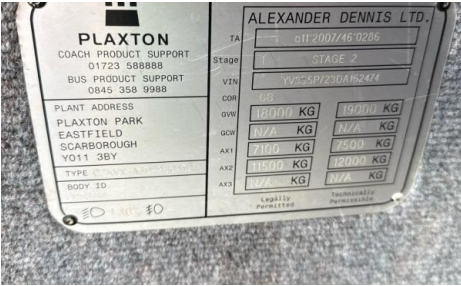



## Condition Check

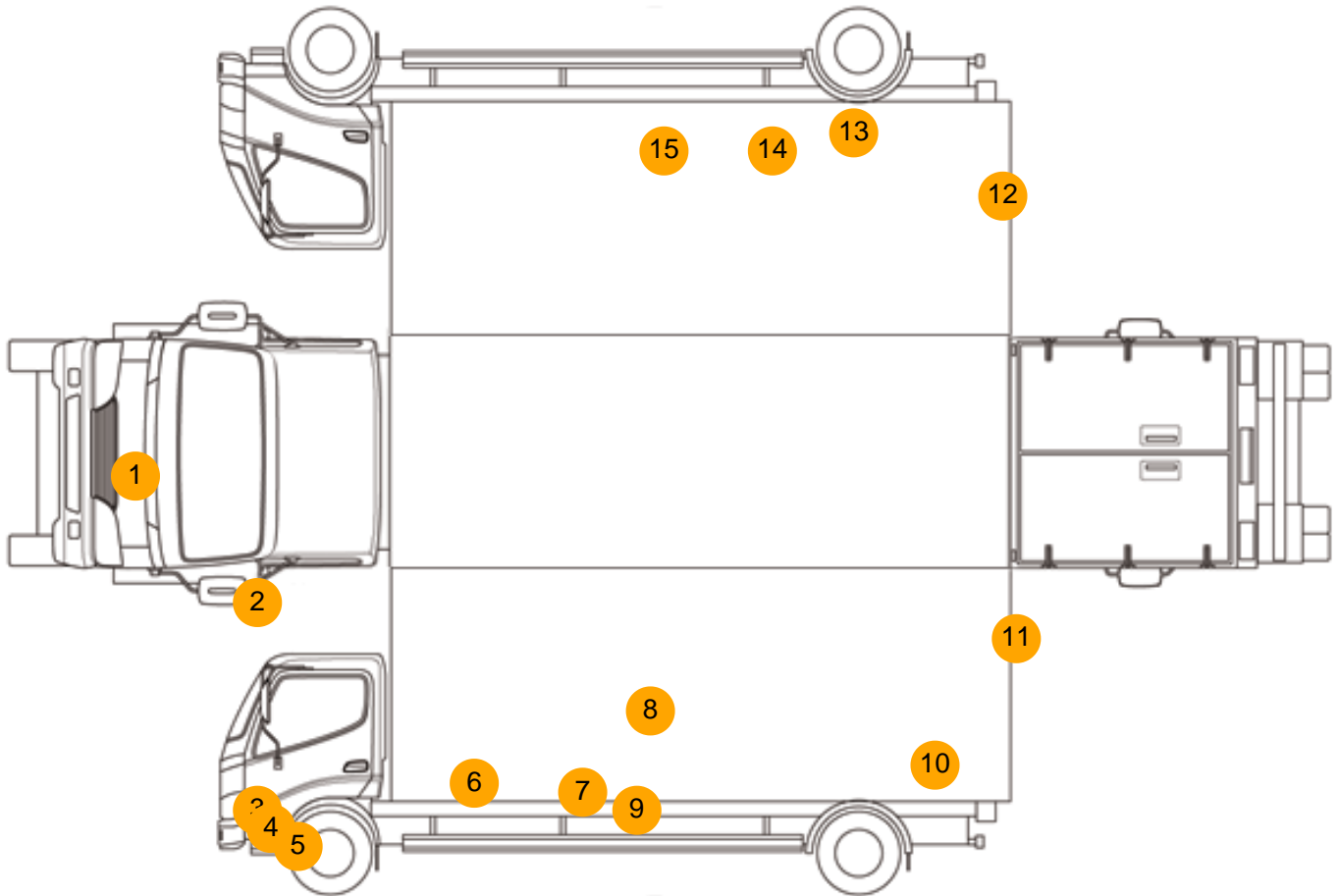

## Damage Photos

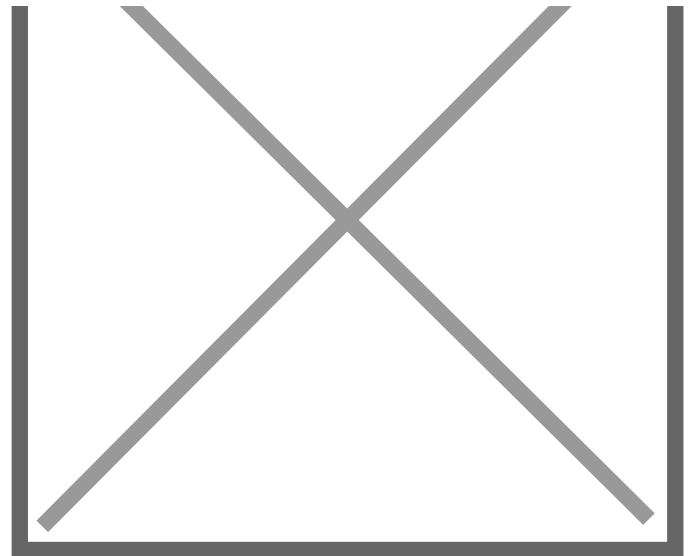
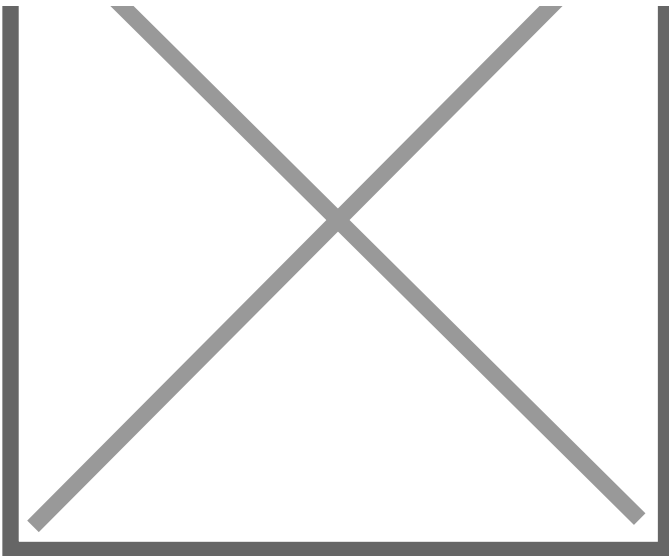

1: Bonnet  
Chipped  
Multiple Chips

2: Door Mirror Assy nsf  
Broken  
Replace

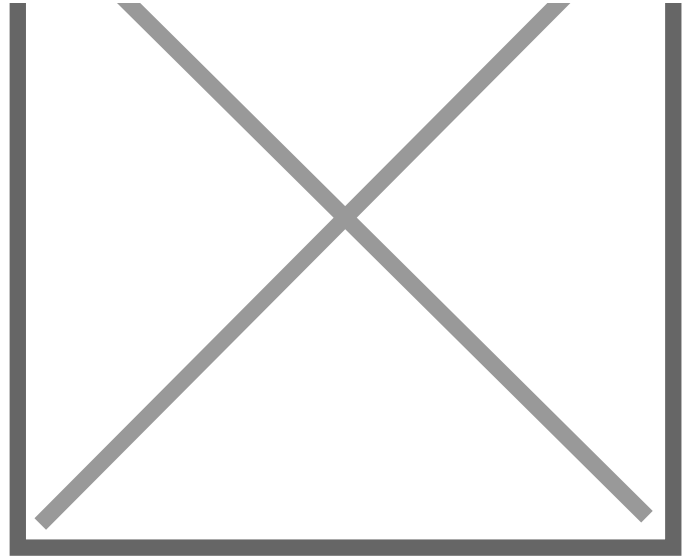
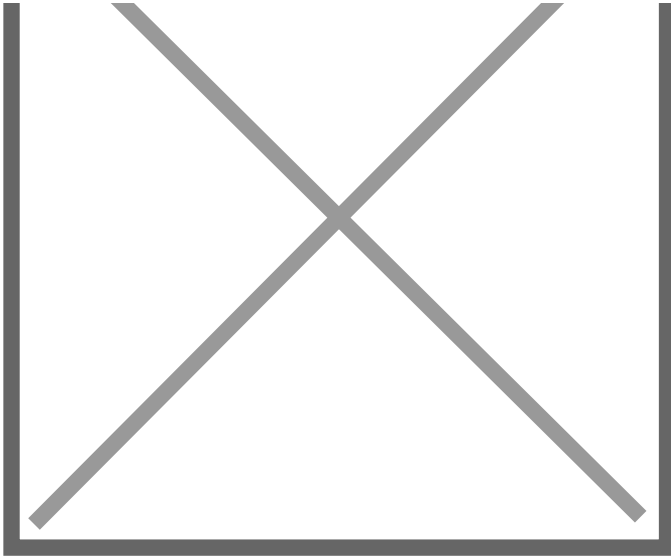

3: Panel Front  
Scratched  
Over 25mm Thru Paint

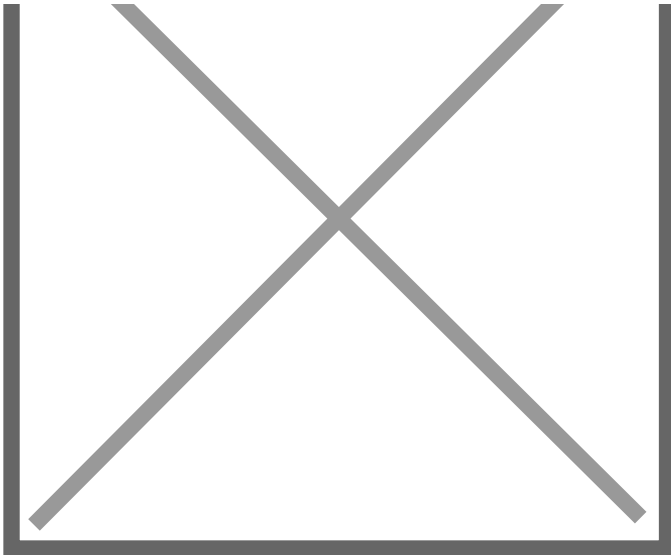

4: A Post ns  
Cracked  
Replace

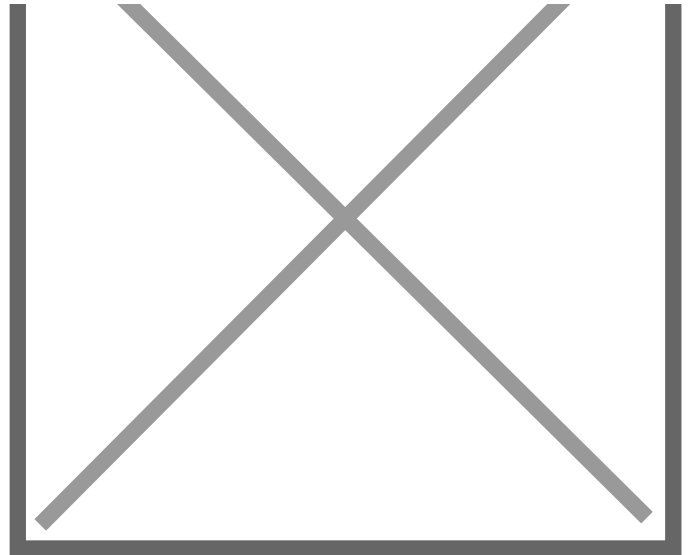

5: Door nsf  
Dented  
With Paint Damage

6: Qtr Panel nsr  
Chipped  
Multiple Chips

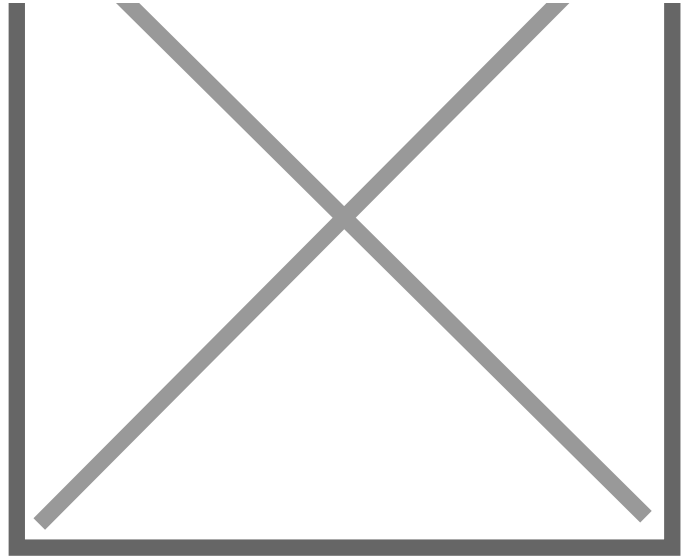
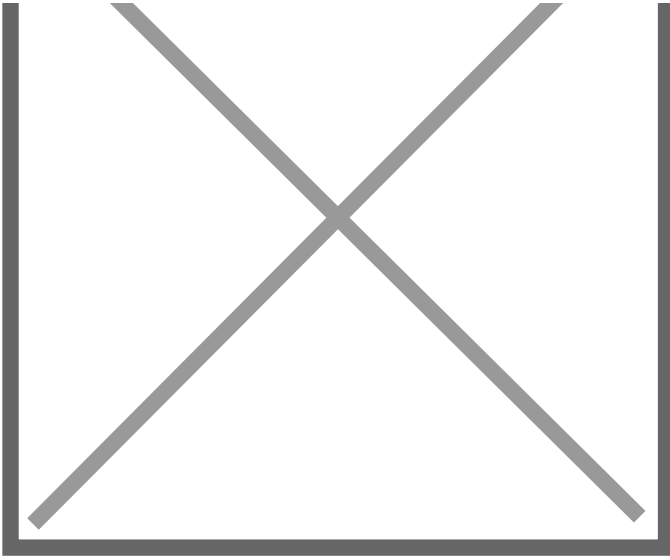

7: Qtr Panel nsr  
Dented  
With Paint Damage

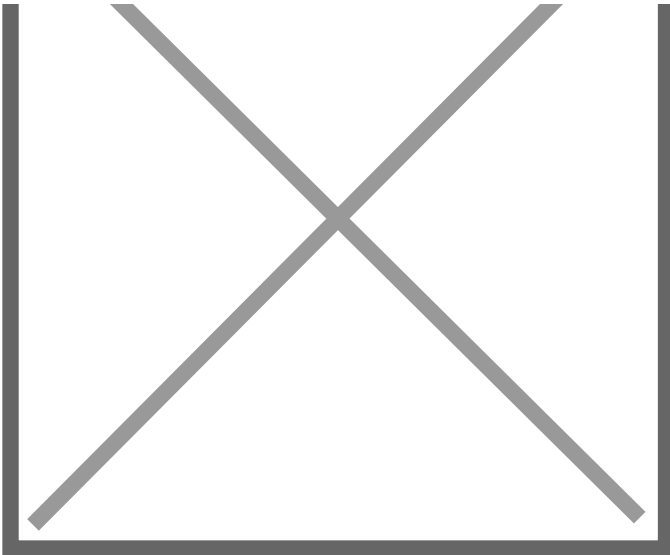

8: Qtr Panel nsr  
Dented  
With Paint Damage

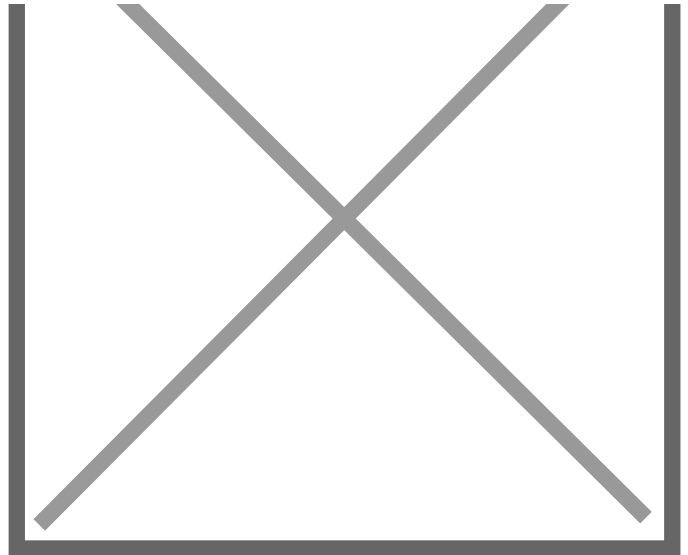

9: Qtr Panel nsr  
Dented  
With Paint Damage

10: Qtr Panel nsr  
Chipped  
Multiple Chips

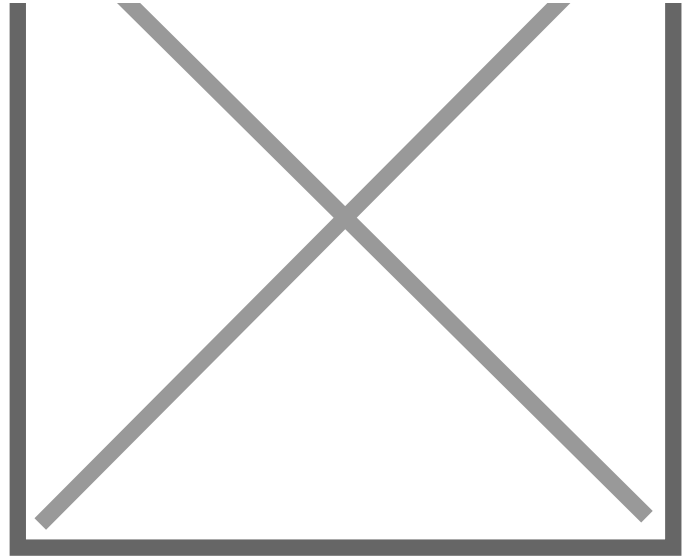
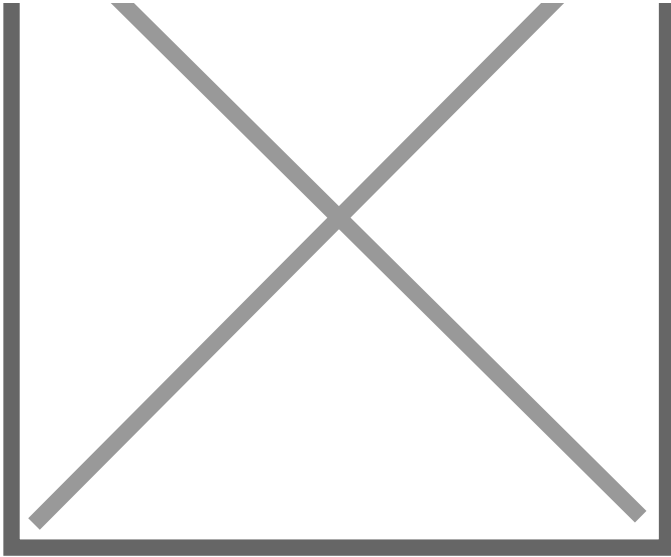

11: Panel Rear  
Scratched  
Over 25mm Thru Paint

12: Panel Rear  
Chipped  
Over 5mm

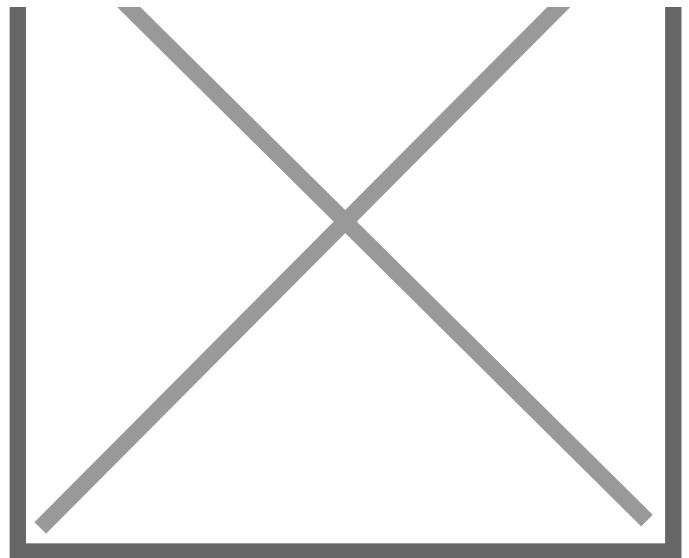
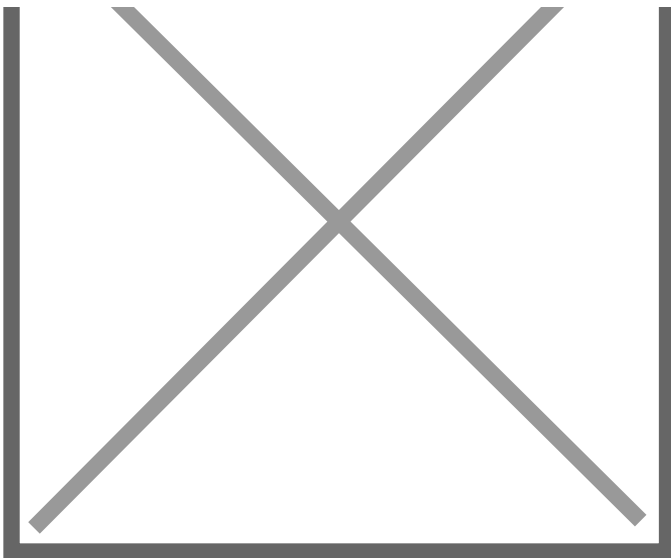

13: Qtr Panel osr  
Dented  
With Paint Damage

14: Qtr Panel osr  
Dented  
With Paint Damage

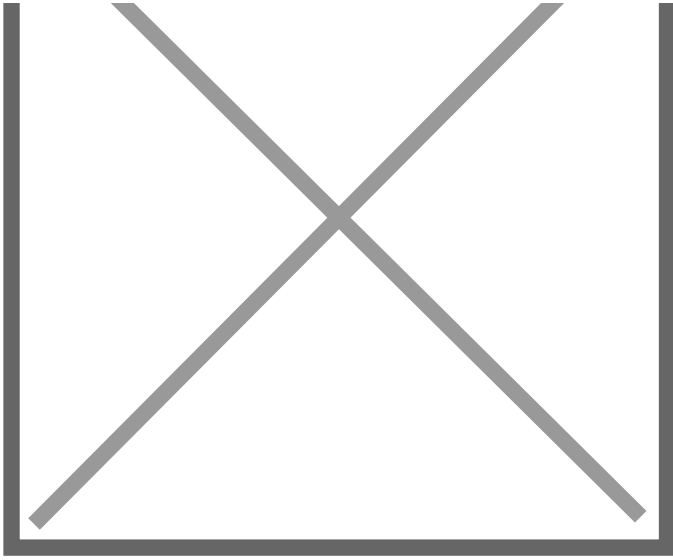

15: Qtr Panel osr  
Chipped  
Over 5mm

**Interior**

**Carpet Condition**

OK

**Upholstery Condition**

OK

**Seat Condition**

OK

**Odour**

-

Engine Runs	OK	No Excessive Smoking	OK
EML light illuminated	OK	DPF light illuminated	OK
ABS light illuminated	OK		